

HYPHN

The Shape of Genius





Hyphn is a statement of intent.

Hyphn is a peerless, definitive, uncompromising demonstration of the Monitor Audio Group's current design, engineering and manufacturing capabilities, and its future ambitions. It is unlike anything Monitor Audio, or anyone else, has ever created: the most creatively ambitious, technically advanced and powerful loudspeaker in the company's history. It delivers a dramatically enhanced listening experience, with a visually striking presence.

Born of Passion, Vision & Knowledge.

Hyphn is born of collaboration between our designers and engineers, who set out to build the best loudspeaker anyone has ever heard. An ambition that's easy to express, but a lot more challenging to achieve.

Hyphn is intended to be a 'statement loudspeaker' both technically and visually. It is also designed for 'real' rooms, taking into account and addressing all the inherent constraints and compromises that entails.



Emily Hessegrave, Senior Designer

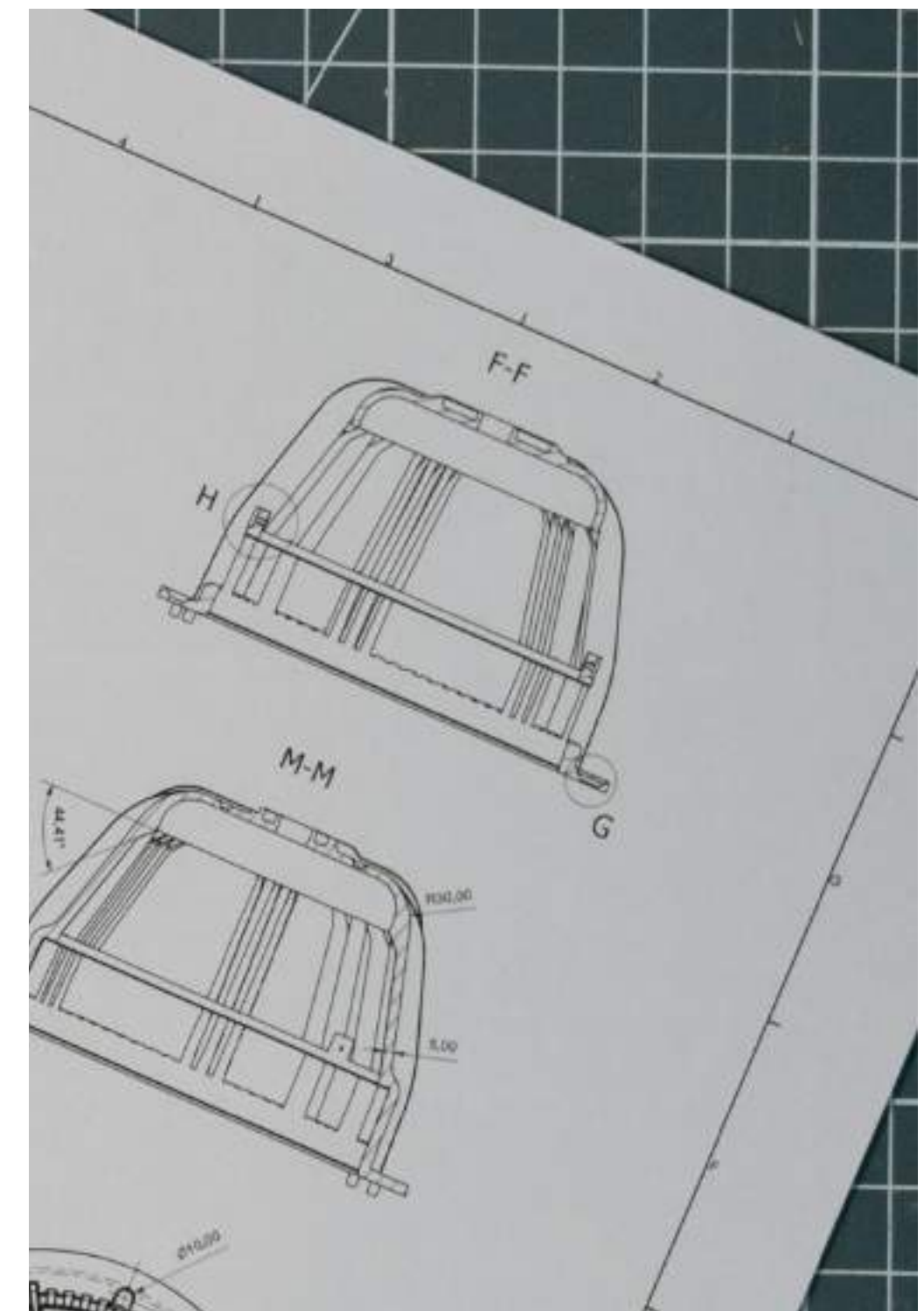

Achieved Through an Inherent Understanding of Sound.

Hyphn is the more refined, further enhanced production version of the Concept 50 loudspeaker, unveiled to enormous media attention and universal acclaim in 2022.

Hyphn is a unique loudspeaker, created at a particular point in time through a combination of three specific factors: a deep understanding of the science of how we hear sound; solid engineering principles; and the creative freedom that comes with being an independent business.

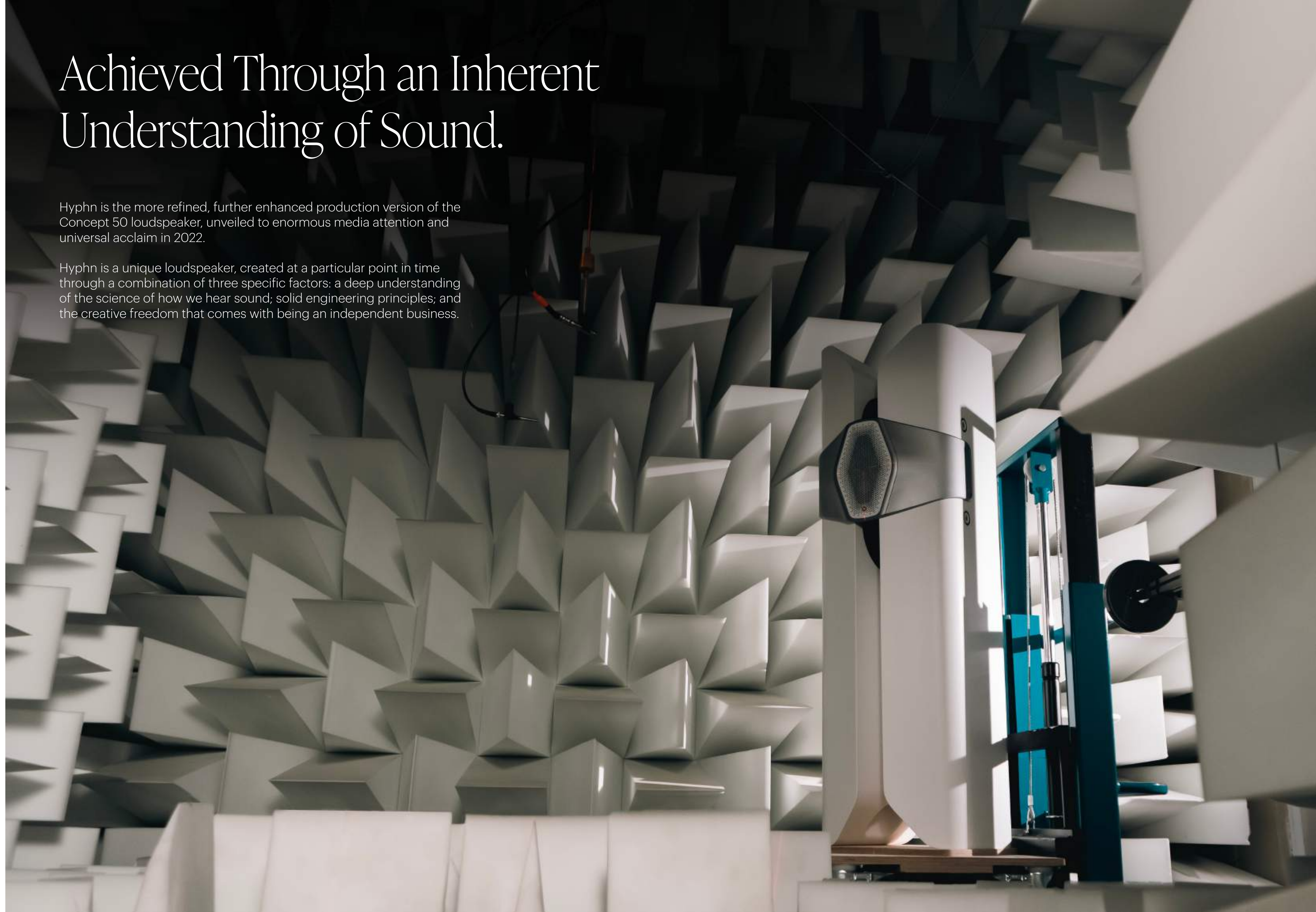

Our Transparent Design Philosophy.

Hyphn is a product of Monitor Audio's Transparent Design Philosophy.

We believe the ultimate loudspeaker is capable of producing sound as laid down by the artist so accurately that it becomes transparent. The physical design should be sympathetic to this in any environment and work in harmony with the desire for transparency.

Hyphn is built upon an R&D philosophy of maintaining a balance between design and technology. One is never allowed to overpower the other and both play a vital role in delivering on our promise of musical neutrality and acoustic transparency.

The physical speakers are designed to sit comfortably within their environment. They are a beautiful statement, but one where perfectly balanced design neutrality means they will blend in for a lifetime of use.

Every Monitor Audio product is the result of intense collaboration, drawing on decades of experience within the design team and ensuring that all the elements of performance, technology and design work in harmony.

Hyphn is the physical manifestation of this.



Creating a speaker nobody
thought possible.





The designers were clear they didn't want to produce a big box with lots of circles on the front. Indeed, their main challenge to themselves was how to create a loudspeaker that didn't look like one.

They also recognised, rightly, that you can't set out to create an 'iconic' design, any more than you can sit down to write a 'bestselling' novel; it's for the market and the audience to judge and grant that status. But they did want the design to be very ownable and distinctively 'theirs'. And they realised early on that in Hyphn, they had something very special indeed.

Achieved Through Total Collaboration.

There's an element of risk in any innovation. With Hyphn, there was no specific background research and no prototyping – because, with the launch date already fixed, there simply wasn't time. But the team applied good, solid science and engineering, so any risks were carefully calculated. And when the science is right and the engineering is sound, you can do it like that, because you know, fundamentally, it will work.

The project was possible only through total collaboration and absolute trust between the design and engineering teams; something companies often lose out on by outsourcing their industrial design. Crucially, the team had the blessing of the business to develop Hyphn free of budgetary and other constraints – one of the huge advantages of being an independent business able to control its own destiny.





The Shape of Genius.

Hyphn's striking outline is a product of the configuration of the drive units; looks are secondary to the technology. Indeed, the concept began with the drive units floating in (virtual) space in the optimum positions; the design team then created the cabinet's physical form around them. And while nothing was done for the sake of decoration, the design consciously focuses on the M-Array, to draw attention to the most important part of the product.

All loudspeakers are essentially architectural – they're called 'towers' after all – but the description is especially apt for Hyphn. In architecture, a 'hyphen' is a link between two separate structures; and in Hyphn, the bridge containing the M-Array provides the only physical connection between the two pillars housing the bass drivers. The design team deliberately avoided anchoring them at the bottom, as logic might have dictated, so as to stop the shape becoming singular.



Engineering the Impossible.

Some of the team's biggest challenges lay in engineering solutions to problems that simply don't exist in a simple box design. For example, where do you run the cables for the two sets of bass drivers so they can't be seen? (Through the middle of the drive unit anchors).

Here, as they had throughout the project, they relied on sound engineering principles, which hold that it's better to make something simple with known issues and fix them, rather than make something highly technical or entirely new. For example, instead of trying to create a 'perfect' rear chamber for the M-Array, they simply made it as small as they practically could, then used foam and other conventional techniques to eliminate any resonances. And as it turns out, the bridge actually enables better acoustics and far exceeds the original expectations on what the engineers thought possible.

A definitive and uncompromising performance.

Acoustically, Hyphn is almost identical to the Concept 50, which was always intended for production. However, beneath the surface, almost everything was reimagined for even better performance.

The six mid-range drivers in the M-Array appear acoustically as a single source. This creates a very detailed sound field, with stereo audio delivered to the best possible capability, with huge depth of sound. The six small, flat surfaces also eliminate intermodulation distortion from the MPD III Transducer, which research shows is more important than harmonic distortion. This is a much better engineering solution than the conventional single coaxial cone, but simply not feasible in a smaller, cheaper loudspeaker.

Hyphn is engineered to be tonally transparent across the full range from 18Hz up to 60kHz. Importantly, it's designed to maintain this performance as it's turned up; it should never sound strained or stressed at any reasonable level in a room.



Perfecting the Art.



Hyphn's unique cabinet is constructed using the highest quality solid surface material available. After lengthy research and testing, we settled on a composite that combines acrylic, minerals and natural pigments. This creates a smooth, thermoformable and visually seamless surface, which is then precision milled to produce Hyphn's striking and distinctive profile.

The acrylic stone material provides the perfect platform from which the drive units can operate to their full amazing potential. It is both totally rigid and naturally inert, so doesn't create any unwanted vibrations within the bass cabinet enclosure.

One of our key brand values and differentiators is that Hyphn is designed, engineered and hand-built in England. This is important for two reasons.

Firstly, customers worldwide still seek out and respect products that are genuinely 'Made in Britain', particularly at the upper end of the market. By emphasising this fact, we're aligning Hyphn with Savile Row, automotive brands including McLaren, Rolls-Royce, Aston Martin and Morgan, Barbour, Fortnum & Mason and other names that help to elevate our own brand.

And secondly, we're nurturing and supporting high-level craft skills, knowledge and experience within our own business – something many companies choose to outsource, or dispense with altogether by employing simpler materials and construction methods and/or automation.

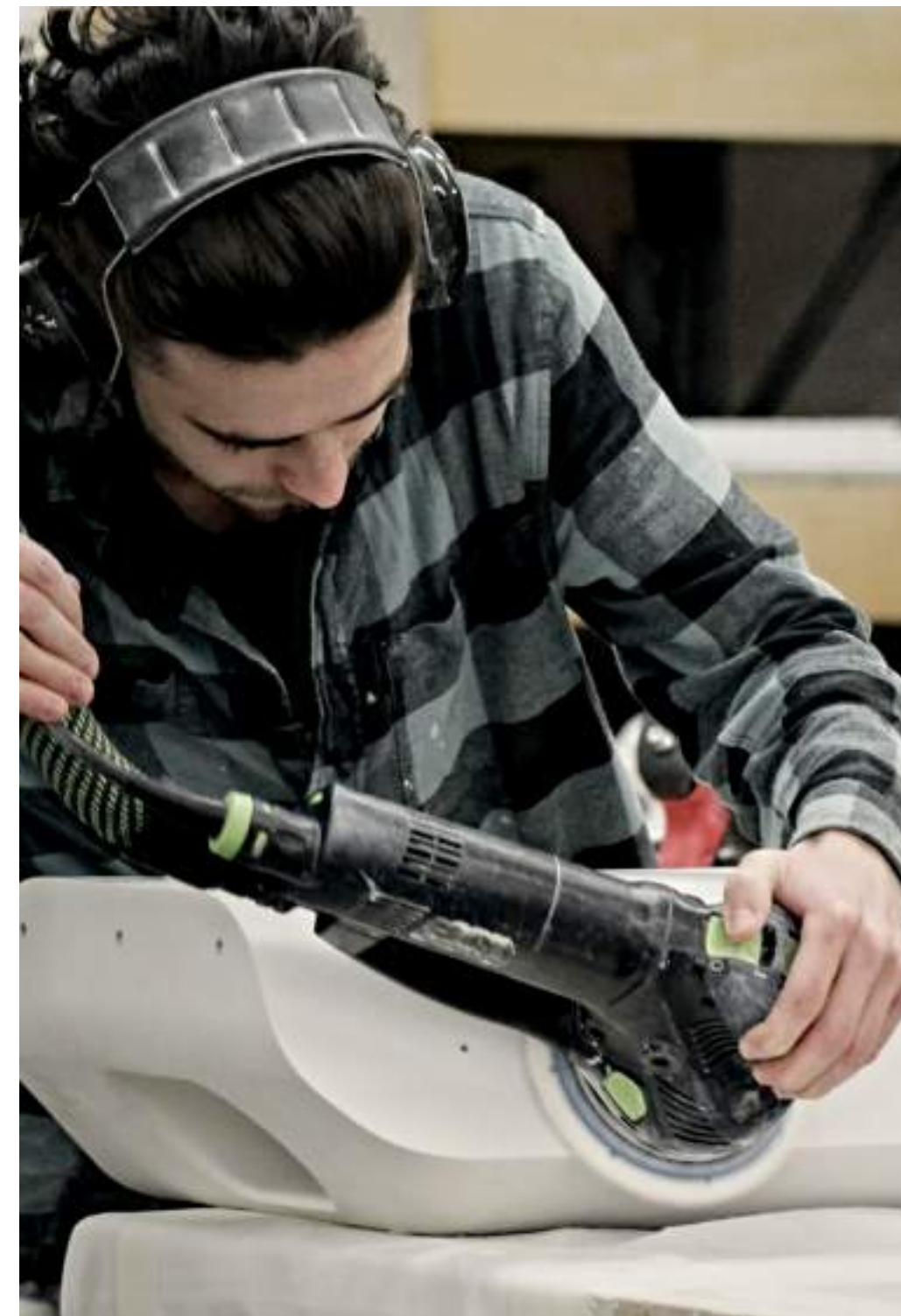





Point Source Driver Array

Hyphn's point-source driver array is located squarely between the twin pillars, each of which houses a pair of powerful 8-inch (203mm) bass drivers.

The unique M-Array configuration features a single Micro Pleated Diaphragm III (MPD III) Transducer surrounded by no fewer than six, 2-inch Rigid Diaphragm Technology III (RDT III) dedicated midrange drivers to deliver sensational acoustic transparency alongside improved off-axis performance.

Hyphn's unique point-source driver array configuration delivers exceptional soundstage clarity, allowing the listener to precisely pin-point individual instruments and vocals for a thrilling acoustic experience.

The M-Array

The M-Array is an ultra-compact multi-driver midrange and tweeter assembly. A masterpiece of intricate detail and design, the M-Array is a testament to the collaborative approach of acoustic and mechanical engineering within Monitor Audio's Research and Development team.

Using our renowned RDT III cone technology, the six midrange drivers together have a surface area that is slightly larger than our Platinum midrange driver. An approach that gives rise to multiple benefits.

Firstly, each midrange has an exceptionally wide bandwidth and can cover much of the range of a traditional tweeter. This ensures the smoothest crossover to the tweeter and exceptionally low distortion.

And secondly, traditional dual concentric drivers suffer from intermodulation distortion due to the displacement of the midrange diaphragm, which forms the tweeter waveguide. This can be reduced by limiting the lowest frequency the midrange operates to but never totally removes it. As Monitor Audio's tweeter waveguide is fixed and the drivers create a flat baffle around the tweeter, there is no additional intermodulation distortion contributed and the midrange can run to its full potential without compromise.

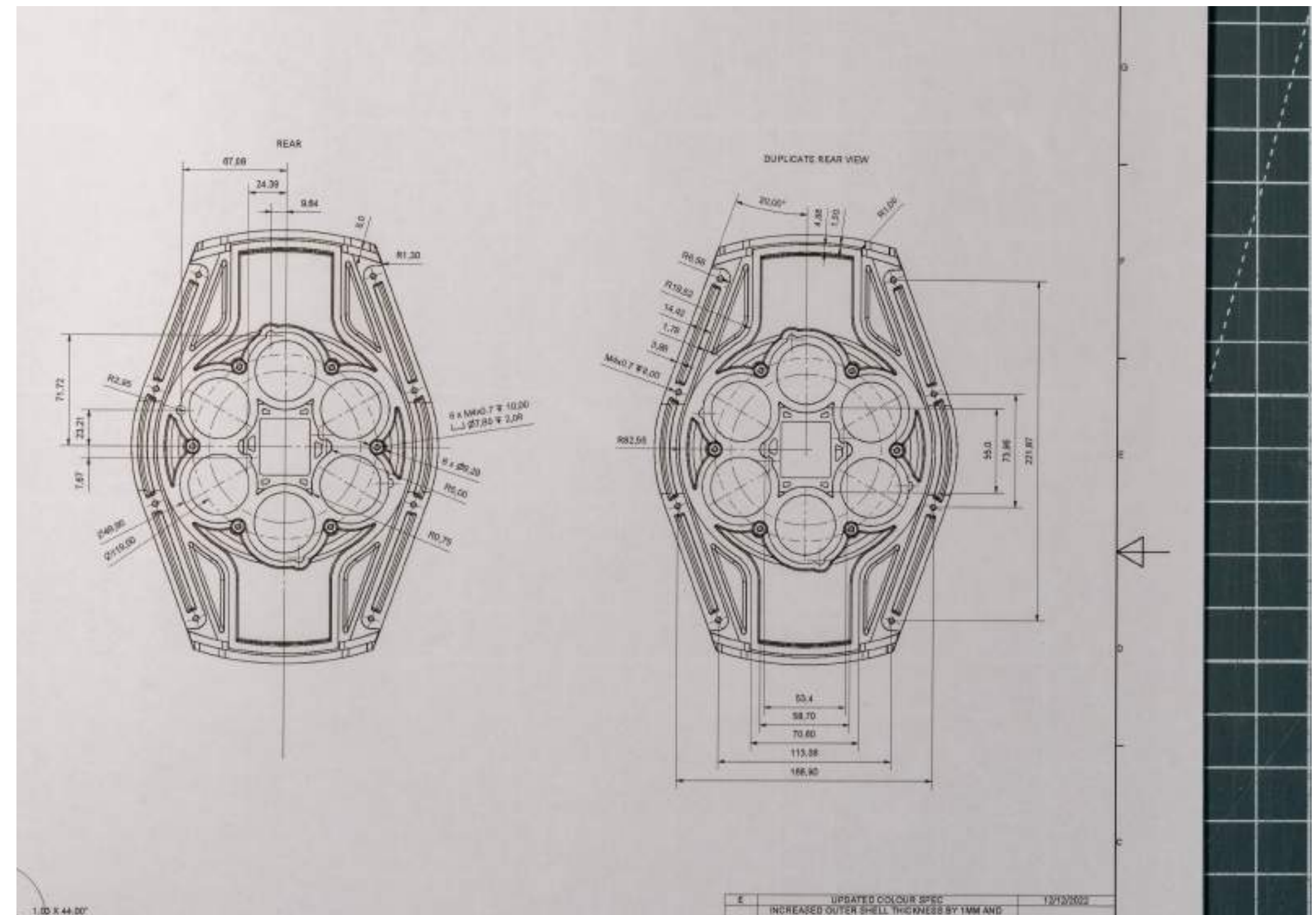

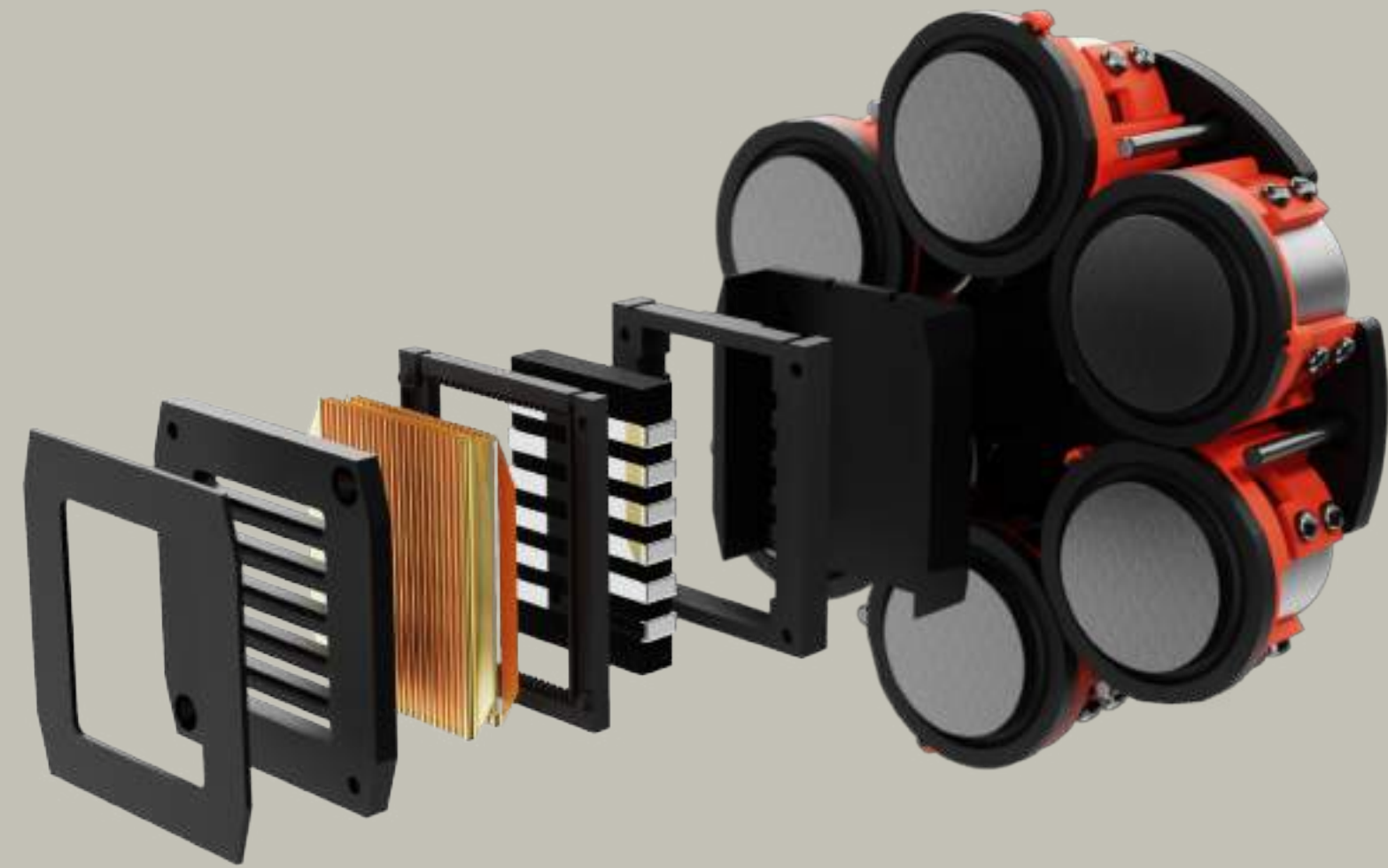

MPD III Transducer

At the heart of the M-Array, sat precisely at the acoustic centre of the six 2-inch midrange drivers, is the Micro Pleated Diaphragm III (MPD III) high-frequency transducer.

Developed by Monitor Audio's acoustic engineers, this accurate transducer was unveiled for Monitor Audio's 50th Anniversary celebrations. It delivers remarkable performance:

- The Micro Pleated Diaphragm III (MPD III) extends tweeter passband to >60 kHz (compared to >40 kHz for a typical AMT)
- Its square radiating area ensures equal directivity in horizontal and vertical planes, resulting in an improved soundstage
- The rear volume is optimised to ensure minimal ripple in audible frequency range, with gentle rise on-axis to deliver exceptional detail
- It features an improved waveguide to give controlled directivity and radiation impedance matching, further improving soundstage and maximising sensitivity

The MPD III Transducer delivers a larger, clearer, and more consistent sound. Music and film are delivered with precision and clarity, allowing the listener to enjoy levels of accuracy and detail beyond what they have experienced before.

Midrange Drivers

Rigid Diaphragm Technology III (RDT III) is a composite 'sandwich' structure made from ultra-thin low mass skins, bonded to a honeycomb Nomex® core material. Extremely light and strong, it can respond with great speed without bending – just like a perfect piston.

RDT III uses Ceramic-Coated Aluminium Magnesium (C-CAM) for the front skin, while the rear skin is made from a woven carbon fibre material. The combination of such a light and strong material structure reduces distortion by over 8 dB above 300 Hz, which makes RDT III the lowest distortion cone technology in Monitor Audio's history.

Why six, 2-inch midrange drivers? Performance first and foremost – it was about achieving the largest amount of surface area (to reduce distortion, projecting vocals effortlessly) with the smallest footprint – the smaller the radiating area of the drive unit, the wider the directivity for the best in-room integration.

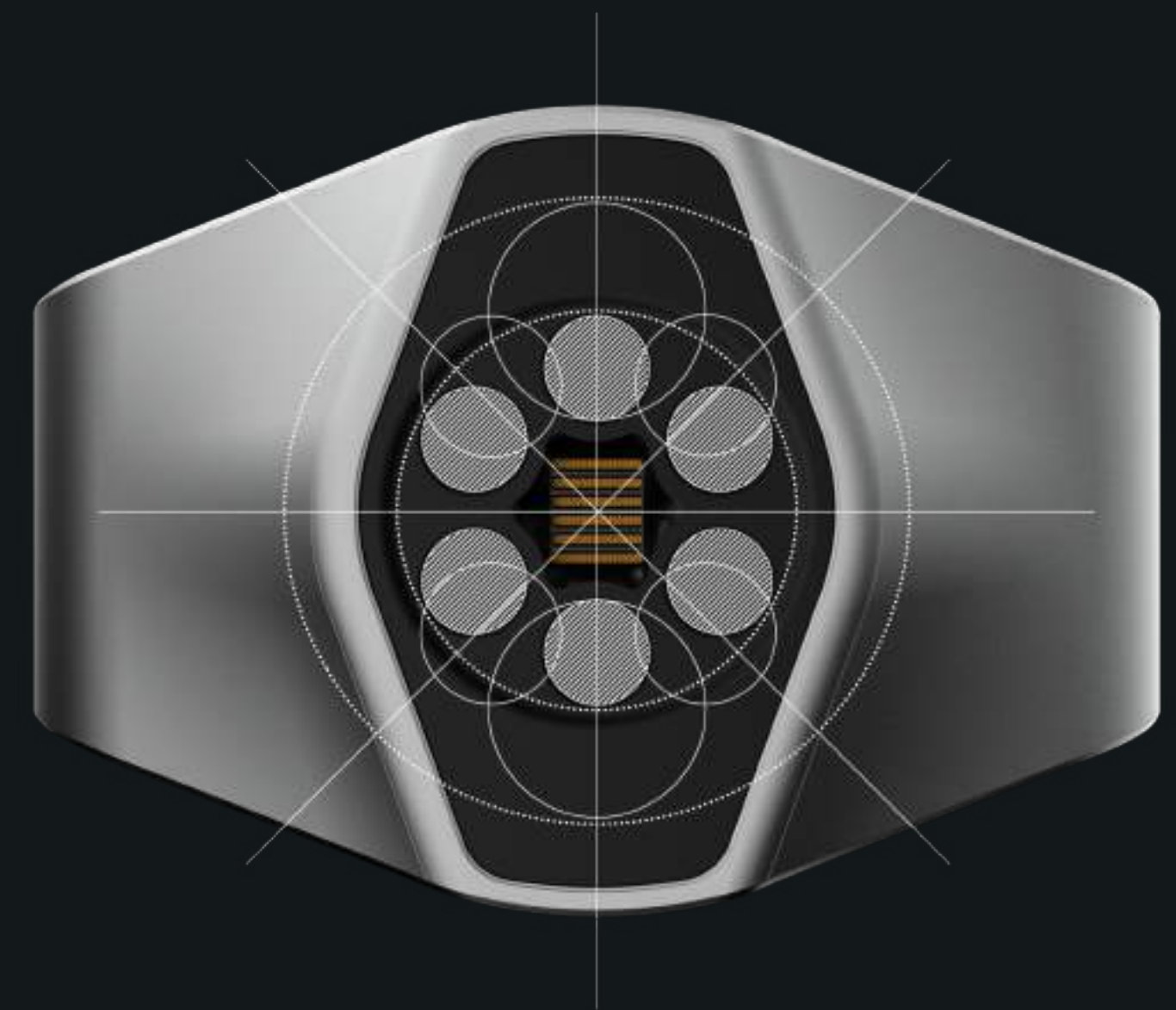



Powerful, Force-Cancelling Bass Drivers

The sheer scale and authority of Hyphn is delivered via no fewer than eight, powerful 8-inch bass drivers – four precisely positioned, and rigidly secured within each Hyphn cabinet.

Each of the four pairs of bass drivers are positioned facing inwards towards each another. They are secured in place by inch-thick metal rods and through-bolt fixings that run through the width of the cabinet to the rear of each bass driver. This fixes the four drive units securely.

The concept of force-cancelled drivers is simple: the same force applied to the cone of both bass drivers means the same force will be applied in the opposite direction – an equal and opposite force.

Face two bass drivers in pairs and the reaction force of one will be the same as the other – equal and opposite. This means there is little or no vibration force from the drivers, either within themselves or passed through into the cabinets.

The result is a cabinet that is almost vibration free, with all the listener hearing is the sound; pure, clean and detailed.



Crossovers

Hyphn has been engineered to deliver enhanced bass control, response and dynamics, plus exceptional detail through the treble and upper midrange. Crossovers are specifically designed to ensure precise, controlled performance across the full frequency spectrum.

As with everything on Hyphn, the smallest details have been considered, even down to baking the inductors in varnish, which binds the wires together to reduce vibration or mechanical resonance. Ceramic wire-wound resistors reduce power compression, and have also been doubled or quadrupled up where necessary to achieve our desired max power handling (800W).

Bass, mid and high frequency sections utilise individual PCBs, which minimises crosstalk and magnetic fields. Boards have been carefully optimised to minimise the interaction between adjacent inductors and mounted on rubber isolation feet within the cabinets, preventing vibration travelling through the PCBs and components, improving sound quality.

Hyphn is the most powerful loudspeaker Monitor Audio has ever produced.

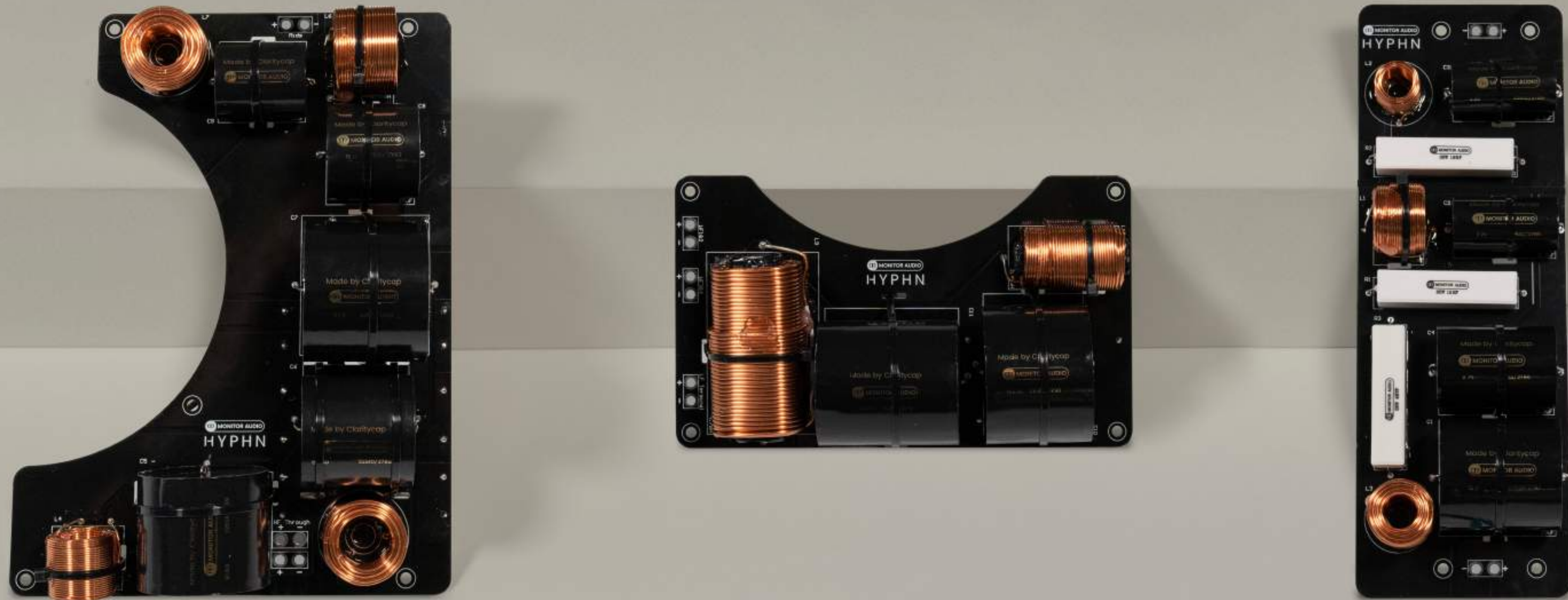



Cabinet

Hyphn's unique cabinet is constructed of thermoformed mineral and acrylic stone. The cabinet is then precision milled. The result: a totally rigid structure that provides the perfect platform from which the drive units can operate.

This naturally inert material is perfect for the Hyphn enclosures. With built-in formed strengthening ribs and bracing, with internal and external wall thickness of 12mm up to 24mm around the force-cancelling bass drivers, the result is a cabinet that is almost vibration free.

Weighing in at over 106kg each (fully built), the smooth lines, and strong visual architectural aesthetic that the cabinets exude will ensure they remain relevant for a lifetime and that the iconic reputation that started with Concept 50 lives on.

Beautifully Finished

Hyphn is expressed in three contemporary finishes, Matte Heritage Green, Matte Black and Pure Satin White. Each showcases the elegant architectural lines of the Hyphn design. Carefully selected to present a feeling of luxury, each finish deepens the connection and lustre of the physical shape, and ensures that Hyphn sits within its environment seamlessly.

Whether as more of a statement centre-piece of sonic power or a subtle sculptural design, disappearing beneath musical notes, Hyphn represents a physical presence and undeniable quality that will last a lifetime.





Specifications

Model	Hyphn
Sensitivity (2.83Vrms @ 1m)	86dB
Recommended Amplifier Power (RMS into 4 Ohm, Music Signal)	200 - 1,600W
Continuous Power Handling (RMS into Nominal Impedance, Pink Noise with 6dB Crest Factor)	800W
Nominal Impedance	4 Ohm
Minimum Impedance (20Hz to 20kHz)	3.5 Ohm @ 2.2kHz
Drive Unit Complement	4x 8" RDTIII Bass Driver 6x 2" RDTIII Midrange Driver 1x MPDIII Tweeter
Frequency Response (In-room, -6dB)	18Hz - 60kHz
Maximum Peak SPL (single speaker @1m Z-Weighted)	129dB
System Format	3-Way
Bass Alignment	Bass Reflex
Port Tuning Frequency	25Hz
Crossover Frequencies	350Hz, 3.7kHz
External Dimensions (Inc. plinth) (H x W x D)	1392 x 502 x 520 mm (54 ^{13/16} x 19 ^{3/4} x 20 ^{1/2} "
Weight (Inc. plinth, ex. packaging)	106.9 kg (235 lbs 10.7 oz)



Scan to learn more about Hyphn or visit monitoraudio.com/hyphn

Monitor Audio Ltd.
24 Brook Road
Rayleigh, Essex
SS6 7XJ
England
Tel: +44 (0)1268 740580
Email: info@monitoraudio.group

monitoraudio.com

©Monitor Audio Ltd. | V1-2023 - Hyphn Brochure

 Read me, keep me or recycle me

