

# Accuphase

DDS FM STEREO TUNER

## T-1200

- Double-tuned front end easily handles high signal levels
- Revolutionary DDS principle for local oscillator
- Variable bandwidth IF filter prevents interference
- Multipath reduction function
- Digital FM demodulator keeps distortion and noise to a minimum
- DS-DC achieves ideal stereo demodulation with DSP technology
- MDS type D/A converter
- Memory buttons give quick access to 20 stations



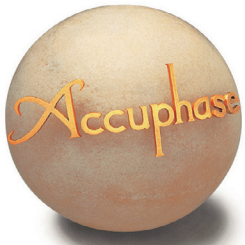

# Discover supreme listening pleasure — with a reference quality FM tuner. The ultimate tool for aficionados of FM stereo broadcasts.

Using a blend of latest RF circuit design with sophisticated digital signal processing, most major functions after the intermediate frequency stage such as the variable bandwidth IF filter, multipath reduction, digital FM demodulator and DS-DC stereo demodulation have been moved to software on the DSP chip. Manual tuning using the pulse tuning method, plus 20-station memory tuning. A digital output provides further flexibility. Realizing impeccable sound quality and outstanding performance in an easy to use format, this FM tuner has been developed for demanding audio and music connoisseurs.

## Innovation – At the leading edge of technology

### Double-tuned front end easily handles high signal levels

The front end not only must provide selectivity for weak radio signals, it also needs to competently handle broadcast stations with strong field strength and convert the signal to the intermediate frequency (IF) while suppressing interference and distortion. The T-1200 performs these tasks brilliantly, thanks to a double-tuned circuit with excellent selectivity characteristics, placed before the RF amplification stage. This proactively prevents intermodulation distortion and blocking which can otherwise occur with strong input signals. The two-stage design with another double-tuned circuit after the RF amplifier further bolsters performance, resulting in excellent sensitivity and selectivity. The double-balanced mixer with differential input also employs a two-stage topology, forming a double super heterodyne circuit. Any type of interference signal is reliably blocked before IF conversion.

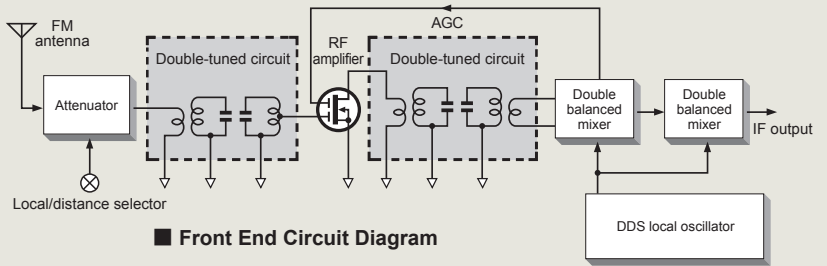

### Revolutionary local oscillator principle: DDS (Direct Digital Synthesis)

The mixer combines the signal from the antenna input with the signal from a local oscillator for conversion into the intermediate frequency (IF). The local oscillator in the T-1200 is a DDS (Direct Digital Synthesis) circuit. In a conventional PLL (Phase Locked Loop) circuit, feedback is used to stabilize the frequency, but this produces frequency modulation components that tend to degrade S/N ratio. With DDS on the other hand, the output of a quartz oscillator is divided to create the digital signal timing that governs the readout of sine wave data and the operation of the D/A converter which produces the analog waveform output. Because there are no frequency modulation components, a highly pure signal with outstanding S/N ratio is created by this revolutionary circuit.

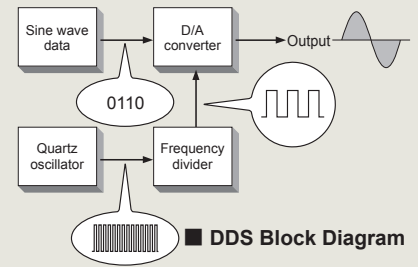
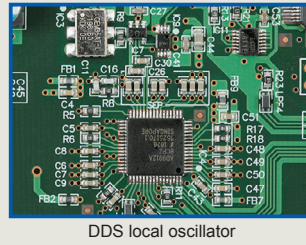

### Variable bandwidth IF filter improves interference performance

The IF BANDWIDTH selector of the T-1200 provides a choice of six settings (50, 75, 100, 150, 250, 500 kHz). Normally, a wider bandwidth setting is preferable in terms of performance characteristics, but by restricting the bandwidth, noise can be reduced in certain situations, making it easier to obtain a good quality signal from a station affected by interference from a strong adjacent station.

The variable bandwidth IF filter is implemented using a FIR (Finite Impulse Response) type digital filter with perfectly linear phase characteristics, thereby eliminating the phase shift that can occur with conventional IF bandwidth filters.

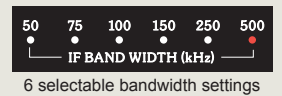
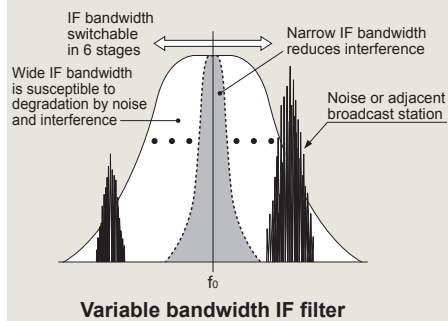

### Multipath reduction (MPR) function minimizes reflections

Multipath reception refers to a condition where the same broadcast signal reaches the antenna via several different propagation routes. In the case of FM, this occurs when the signal travels to the antenna in a straight line, but is also reflected and therefore slightly delayed by buildings, mountains or other tall obstructions. When the direct waves and reflected waves are received together, distortion and noise occur.

The high-speed, high-precision DSP chip in the T-1200 makes it possible to perform multipath reduction (MPR) through signal processing that effectively suppresses the harmful reflected components. This technique, which is based on adaptive filtering principles, greatly reduces reflected wave components and ensures that only the desirable direct wave components are received, resulting in high-quality audio output.

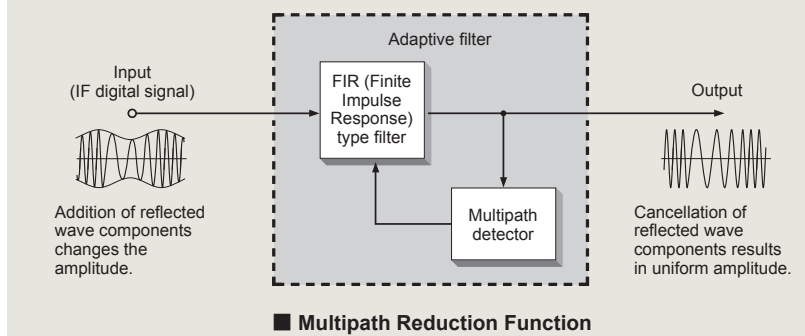

### Digital FM demodulator keeps distortion and noise to a minimum

The FM demodulator circuit is a crucial component that has a significant effect on distortion and noise characteristics of the tuner's audio output. In the T-1200, the imaginary part of the digitized FM signal is divided by the real part to extract the tangent of the phase angle ( $\theta$ ). By calculating the arctangent from this, the phase angle can be determined. Differentiation is then used to obtain the time variation of the phase angle resulting in the FM demodulated output (audio output).

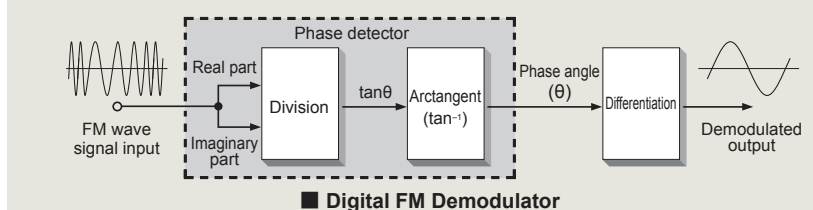

### Memory slots for 20 stations

The station buttons make it easy to store and recall up to 20 broadcast stations. The settings for MUTE, MODE, LOCAL, MPR and IF BANDWIDTH are also stored at the same time, making it possible for example to memorize different settings for various reception conditions and instantly access them as needed.





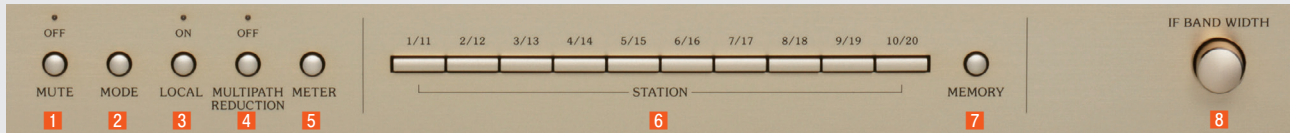

- 1 MUTE button** eliminates inter-station noise.
- 2 MODE button** allows selection of Stereo / Blend / Mono.
- 3 LOCAL button** enables attenuation of excessive antenna input levels.
- 4 MULTIPATH REDUCTION button** improves reception of direct waves by suppressing reflected waves.
- 5 METER button** switches between signal indication and multipath indication.
- 6 STATION buttons** give access to 20 broadcast stations.
- 7 MEMORY button** serves for storing stations in STATION buttons.
- 8 IF BANDWIDTH knob** helps to reduce interference from adjacent stations.

### DS-DC achieves ideal stereo demodulation with DSP technology

The stereo demodulator in the T-1200 features a principle called DS-DC (Direct Synthesis – Double Cancellation). The demodulator comprises the two technologies described below. Since all operations are carried out in the digital domain through software-based algorithms in the DSP chip, ideal stereo demodulation performance can be achieved, resulting in amazingly high channel separation.

#### 1 Pilot Tone Direct Synthesis

A conventional FM tuner uses a PLL circuit to extract the pilot tone and obtain the frequency and phase components from the input signal (stereo-modulated signal). If the level of the pilot tone decreases, noise will be heard and stereo separation becomes extremely poor. With DS-DC, the pilot tone in the input signal is identified and directly generated by the DSP arithmetic. Therefore, even when there is a high level of noise, pilot tones can be reliably generated. This means that impressive stereo separation is achieved also at low pilot tone levels.

#### 2 Crosstalk Double Cancellation

After the input signal has been separated into the left and right components, the circuit eliminates crosstalk using a dual approach that also takes phase components into consideration. The result is extremely thorough left/right separation.

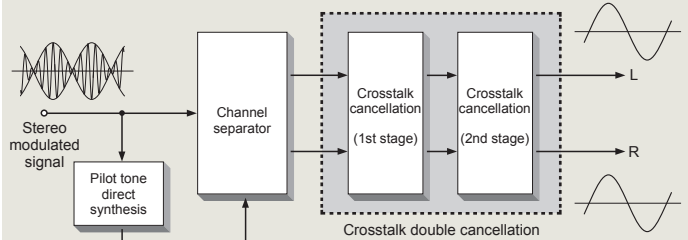

■ DS-DC Type Stereo Demodulator Circuit



DSP chip for DS-DC

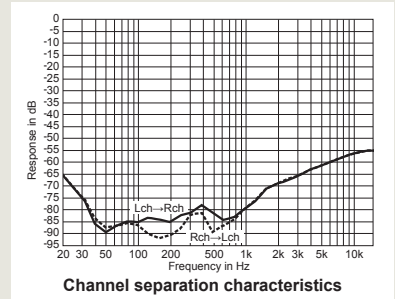

Channel separation characteristics

#### ■ Supplied Remote Commander RC-430

Enables control of all functions of the tuner except power on/off. Also allows volume control with Accuphase-amplifiers.





## Advanced Features

- **MDS type D/A converter**
- **Station buttons give quick access to 20 broadcast stations**
- **Accuphase original pulse tuning system provides traditional manual tuning feel**
- **Confirmation beep when operating tuning knob and function buttons**
- **High-quality digital output connector (coaxial)**
- **Attenuator function for reducing antenna input level**
- **Muting circuit eliminates inter-station noise**
- **Balanced and Line analog outputs using Direct Balanced Filter circuit**
- **MODE button allows selection of desired reception mode**

- ① **STEREO:** Normal stereo reception
- ② **BLEND:** Left and right signals are mixed, to reduce noise particularly in the upper frequency range
- ③ **MONO:** Stereo broadcast reception forced to monophonic mode

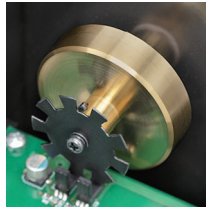

Pulse tuning system



Digital output connector



MODE selection

### Meter for monitoring signal status

Provides a clear visual indication of signal strength as well as multipath condition and effect of multipath reduction.

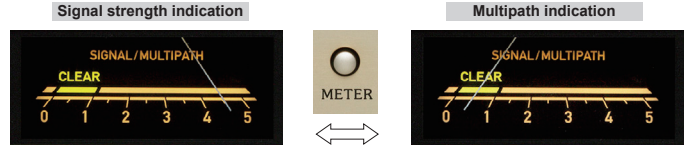

### Multipath reduction function

This sophisticated function effectively suppresses problems caused by multipath reception.



### Balanced output polarity selector

- The default switch position at the time of shipment is as shown here (pin ③ +).
- Sliding the switch to the right selects the "pin ② +" position.

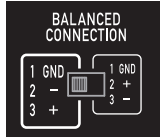

### Front Panel

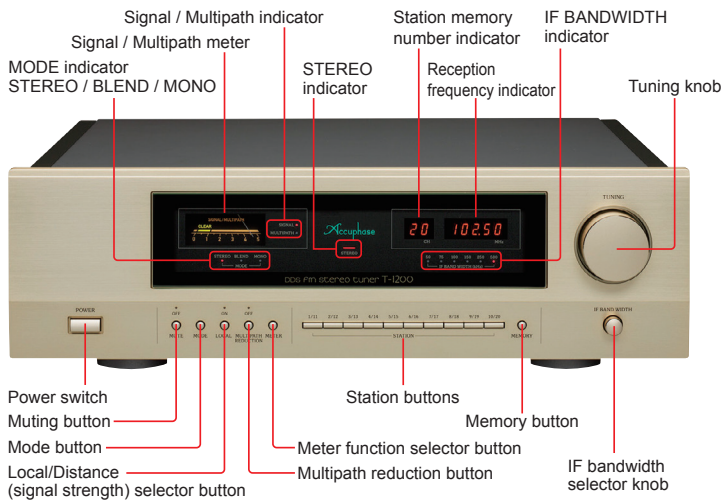

### Rear Panel

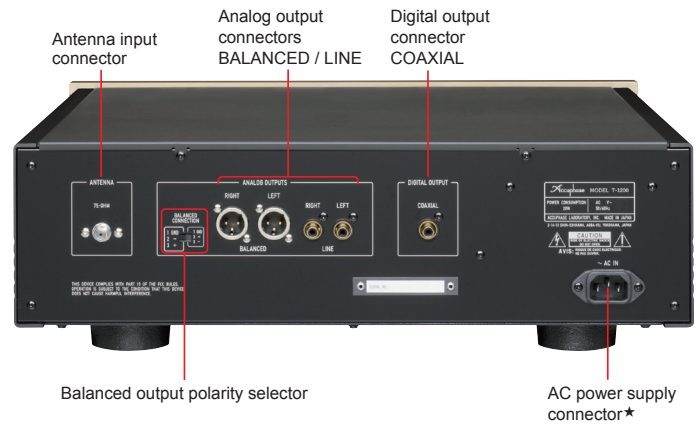

## T-1200 Guaranteed Specifications [Guaranteed specifications are measured according to IEC 60315-4.]

### ◆ Reception frequency range: 87.5 to 108.0 MHz

The tuning step width depends on the destination country.

#### Monophonic

<b>Sensitivity</b>	Usable sensitivity	9 dB $\mu$ V
	S/N 50 dB quieting sensitivity	12 dB $\mu$ V
<b>S/N ratio</b> (85 dBf input, A-weighted)		92 dB
<b>Total harmonic distortion</b> (85 dB $\mu$ input, $\pm$ 75 kHz deviation)		
	20 Hz	0.02%
	1 kHz	0.02%
	10 kHz	0.02%
<b>Frequency response</b>	10 to 15,000 Hz	+0 -2.0 dB
<b>Alternate channel selectivity</b> (IF bandwidth 250 kHz)		
	Interference signal	Selectivity
	400 kHz	70 dB
	300 kHz	30 dB
	200 kHz	10 dB
<b>Capture ratio</b>		1.5 dB
<b>RF intermodulation</b>		80 dB
<b>Spurious response rejection</b>		120 dB
<b>Image rejection</b>		100 dB
<b>AM suppression</b> (70 dB $\mu$ input)		80 dB

#### Supplied accessories

- AC power cord
- Audio cable with plugs (1 m)
- Remote Commander RC-430

#### Remarks

- ★ This product is available in versions for 120/220/230 V AC. Make sure that the voltage shown on the rear panel matches the AC line voltage in your area.
- ★ 230 V version has an Eco Mode that switches power off after 120 minutes of inactivity.
- ★ The shape of the AC inlet and plug of the supplied power cord depends on the voltage rating and destination country.
- ★ The reception frequency range, number of display digits, and tuning frequency steps differ in models for different countries. The antenna connector may also be an IEC type or F type connector. Please verify that you have the correct model for your area.

**Rated output voltage** ( $\pm$ 75 kHz deviation) 1.0 V

#### Stereo

<b>Sensitivity</b>	S/N 40 dB quieting sensitivity	18 dB $\mu$ V
	S/N 50 dB quieting sensitivity	30 dB $\mu$ V
<b>S/N ratio</b> (85 dBf input, A-weighted)		76 dB
<b>Total harmonic distortion</b> (85 dB $\mu$ input, $\pm$ 75 kHz deviation)		
	20 Hz	0.04%
	1 kHz	0.04%
	10 kHz	0.04%
<b>Frequency response</b>	10 to 15,000 Hz	+0 -2.0 dB
<b>Stereo separation</b>		
	100 Hz	65 dB
	1 kHz	65 dB
	10 kHz	50 dB
<b>Stereo trigger level</b>		9 dB $\mu$ V
<b>Subcarrier suppression ratio</b>		70 dB

#### General

<b>Antenna input</b>	75-ohm coaxial (F type connector)
<b>Standing wave ratio</b>	1.5

<b>Tuning principle</b>	DDS synthesizer tuning 20-station random memory tuning
<b>Variable bandwidth IF filter</b>	50 kHz, 75 kHz, 100 kHz, 150 kHz, 250 kHz, 500 kHz switchable
<b>FM detection principle</b>	Digital FM demodulator
<b>Stereo demodulation principle</b>	DS-DC
<b>Digital output</b> (IEC 60958)	
	COAXIAL: 0.5 V <sub>P-P</sub> 75 ohms
	Sampling frequency: 48 kHz / 24 bit
<b>Output impedance</b>	
	BALANCED (XLR type connector): 100 ohms (50 ohms / 50 ohms)
	LINE (unbalanced): 50 ohms
<b>Meter</b>	Signal strength / Multipath, switchable
<b>Power requirements</b>	AC 120 V/220 V/230 V 50/60 Hz (Voltage as indicated on rear panel)
<b>Power consumption</b>	20 W
<b>Maximum dimensions</b>	Width 465 mm (18.30") Height 151 mm ( 5.96") Depth 406 mm (16.00")
<b>Mass</b>	13.0 kg (28.7 lbs) net 19.0 kg (41.9 lbs) in shipping carton