

ADVANCE
PARIS

A12 | APEX

30TH EDITION

USER MANUAL

version 1 - dec. 2025

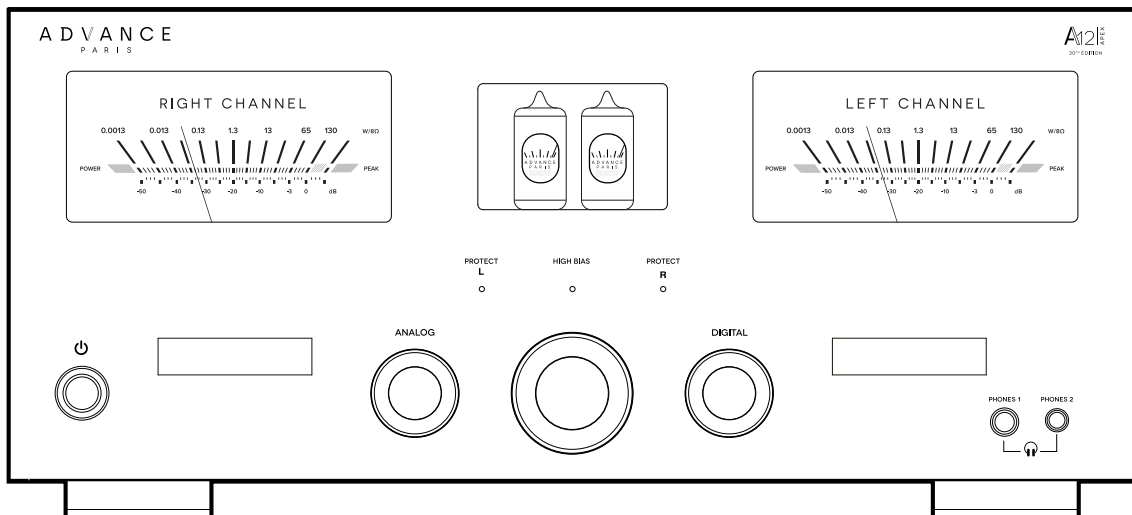

ENGLISH

USER'S MANUAL

The Advance Paris team would like to thank you for choosing an A12 APEX amplifier.

To take full advantage of its performance and ensure optimal operation, please read this user manual carefully before using your amplifier for the first time.

Once you have finished reading it, we recommend that you keep this manual for future reference. This user manual also can be found on the A12 APEX product page on the Advance Paris website.

Table of contents

Contents

Accessories	5
-------------------	---

Description

Front panel	7
Rear panel	8
Remote control	9

Connections

Speaker connection	11-13
Subwoofer connection	14
Connecting a TV	15
Home cinema system	16-17
Connecting a turntable	18
Connecting a source	19
Connecting a computer	20
Connecting with Bluetooth	21
Connecting a recording device	22
Connecting a wired headset	23
Connecting an external amplifier	24
Switch on a product at the same time as your amplifier	25
Connecting the power cord	26

Usage

Switch on	28
Wake from Standby	29
Selecting the input	30
Volume adjustment	31
Muting	32
Using a device connected to the A-BTC	33
Using a Bluetooth headset with the A-BTC	34
Using your TV as an audio source	35
Using your APEX as a power amplifier	36
Using your turntable	37

Settings

How to access the settings menu with the remote control	39
How to access the settings menu with the multifunction control	40
Speaker output configuration (A/B)	41
Subwoofer output configuration	42
Adjusting the speakers when using Bluetooth headphones	43
Adjusting the brightness	44
Setting the automatic standby mode	45
Tone and balance adjustment	46
Loudness adjustment	47
Volume adjustment at start-up	48
Deactivating the Standby button light	49
Capacitance adjustment (PHONO input)	50
Cell type setting	51
Disable HDMI CEC control	52
High-Bias Setting	53
Reset	54

Update / Frequently Asked Questions

Internal software information	56
Update	57
Frequently asked questions	58

Appendices

Glossary	60-62
Dimensions/Weight	63
Specifications	64



CONTENTS

DESCRIPTION

CONNECTIONS

USE

SETTINGS

FAQ

APPENDICES

Accessories

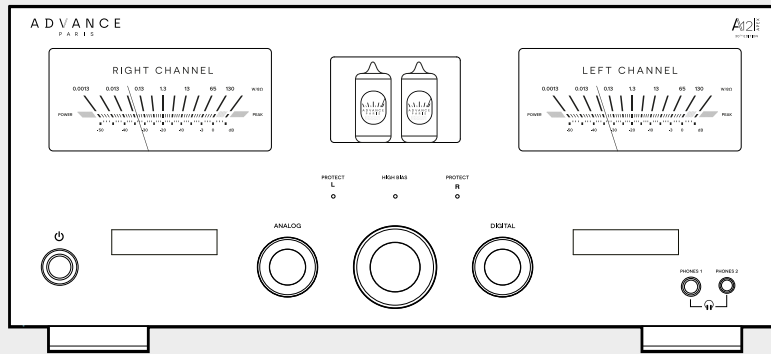

A12 APEX

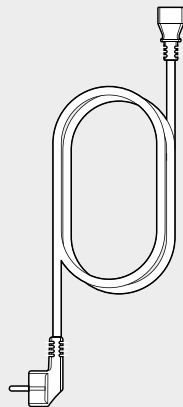

Power cord

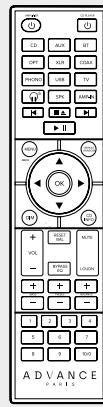

Remote control
REM-19

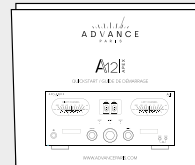

Quickstart



Safety instructions

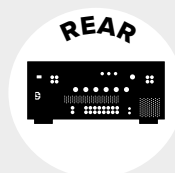



CONTENTS	DESCRIPTION	CONNECTIONS	USE	SETTINGS	FAQ	APPENDICES
----------	--------------------	-------------	-----	----------	-----	------------

Front panel	.7
Rear panel	.8
Remote control	.9

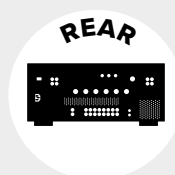



EN

CONTENTS

DESCRIPTION

CONNECTIONS

USE

SETTINGS

FAQ

APPENDICES

Front panel



Always install your hi-fi system with the devices disconnected from the mains.

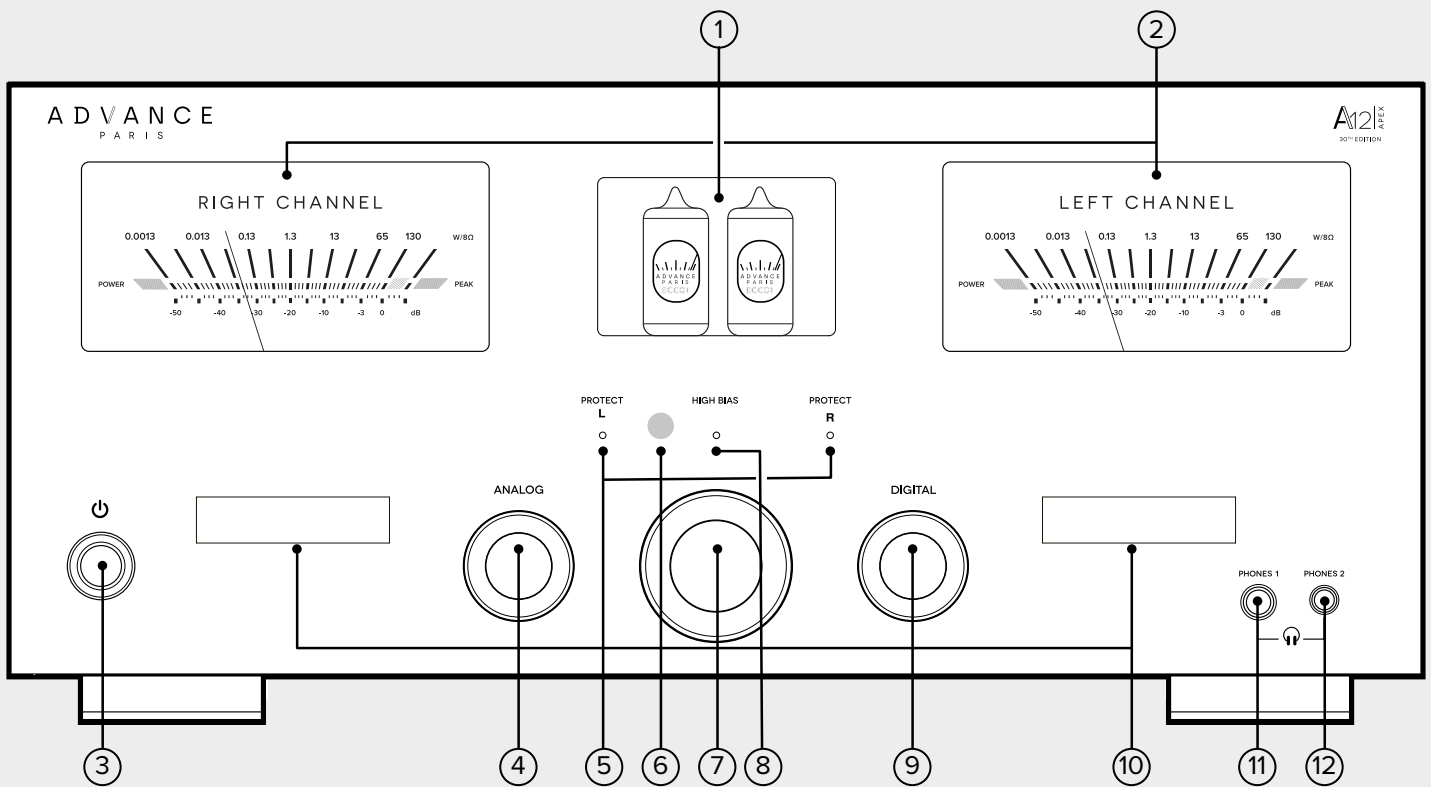

Press the Multifunction control for more than one second to access the various settings menus of your APEX amplifier. Turn the Multifunction control to scroll through the various settings menu entries. To enter a specific setting, press the Multifunction button briefly. To return to the previous level, press and hold the Multifunction control.

- ① Tubes
- ② VU-meter
- ③ Standby button
- ④ Analog inputs button
- ⑤ Protection diodes (Protect L and Protect R)
- ⑥ Infrared receiver
- ⑦ Multifunction control (Volume / Adjustment)
- ⑧ High-Bias
- ⑨ Digital inputs button
- ⑩ Display
- ⑪ 6.35 mm headphone jack
- ⑫ 3.5 mm headphone jack

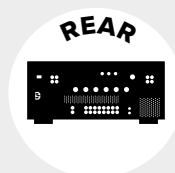

Rear panel

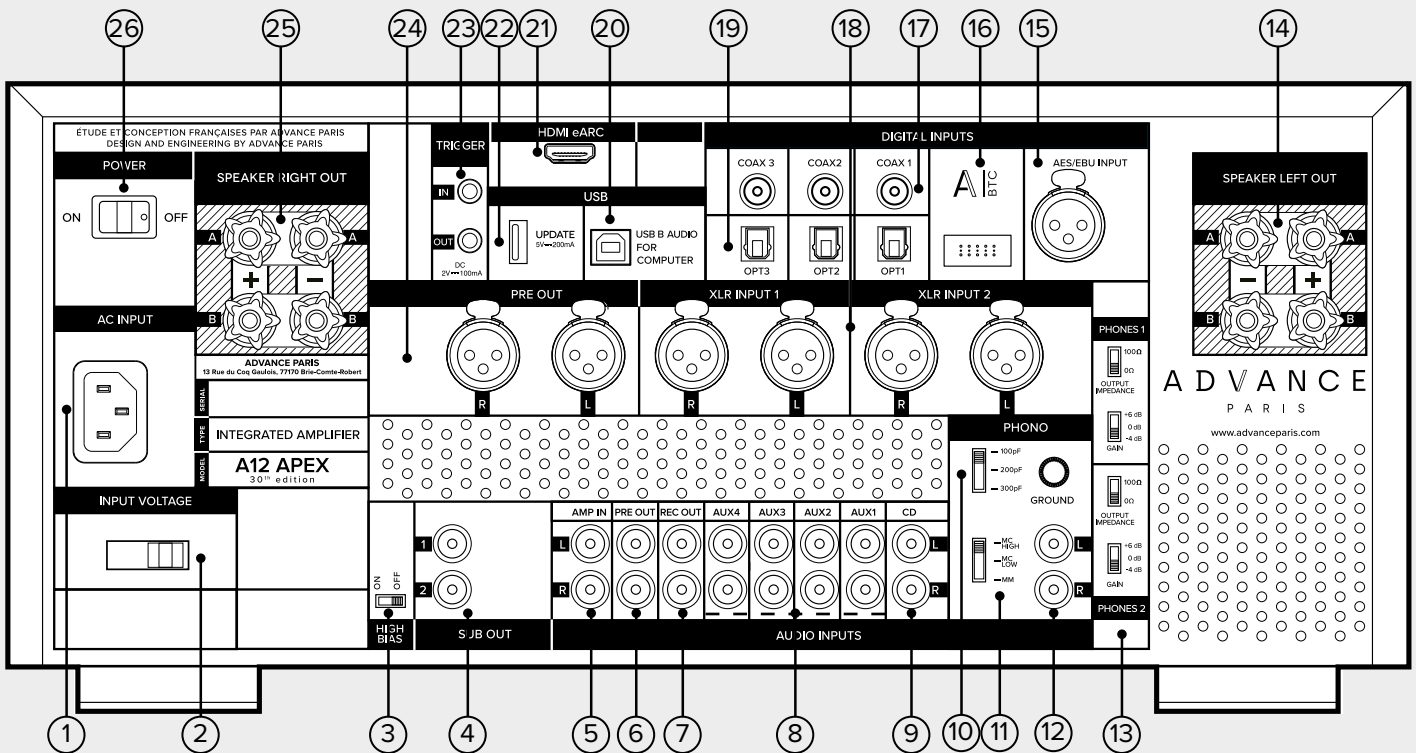

- | | | |
|--------------------------------|---------------------------------|-------------------------------|
| ① Mains socket | ⑩ Capacitance setting (MM) | ⑲ Optical digital inputs (X3) |
| ② Voltage selection (115-230V) | ⑪ Cell type setting | ⑳ USB computer port |
| ③ High-Bias setting | ⑫ Phono MM/MC input with ground | ㉑ HDMI eARC |
| ④ Subwoofer outputs (X2) | ⑬ Headphone adjustment | ㉒ USB Update ONLY |
| ⑤ AMP-IN input | ⑭ Left speaker terminal | ㉓ Trigger IN-OUT |
| ⑥ PRE-OUT RCA output | ⑮ AES/EBU input | ㉔ PRE-OUT XLR output |
| ⑦ REC-OUT output | ⑯ A-B/T input | ㉕ Right speaker terminal |
| ⑧ AUX inputs (X4) | ⑰ Coaxial digital inputs (X3) | ㉖ Mains switch |
| ⑨ CD input | ⑱ XLR inputs (X2) | |

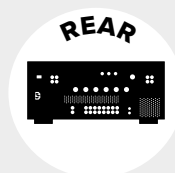

Remote control



To avoid damage to the remote control or battery leakage :

- Do not mix new and used batteries, or different types of batteries.
- When not in use for a long time, remove the batteries.
- In case of leakage, clean the battery compartment before reinserting batteries.

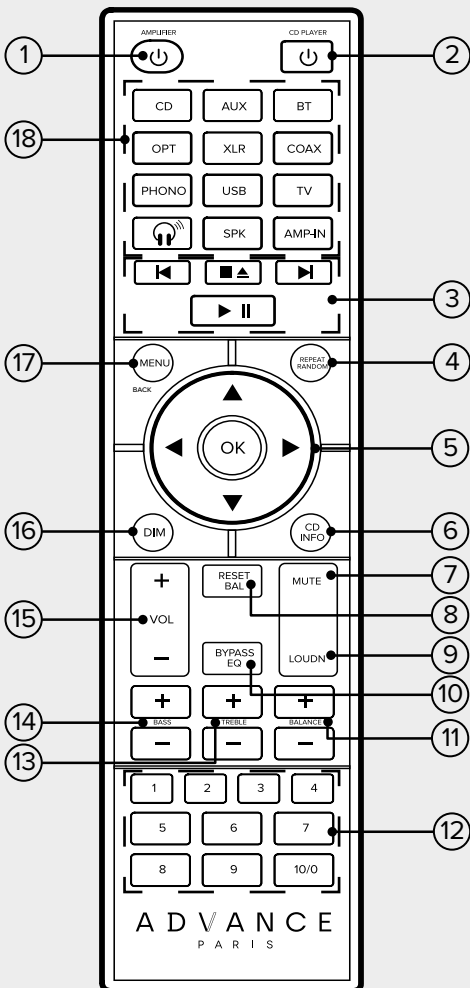

- ① Switch on/Switch off
- ⑤ OK = select
Arrows = next/previous
- ⑦ Mute
- ⑧ Balance Reset
- ⑨ Loudness
- ⑩ EQ deactivation
- ⑪ Balance adjustment
- ⑬ Treble adjustment
- ⑭ Bass adjustment
- ⑮ Volume control
- ⑯ Brightness adjustment
- ⑰ Menu
- ⑱ Sources selection

The buttons in the areas

- ④ ② ③ ⑥ ⑫

are specific to
ACD APEX CD player

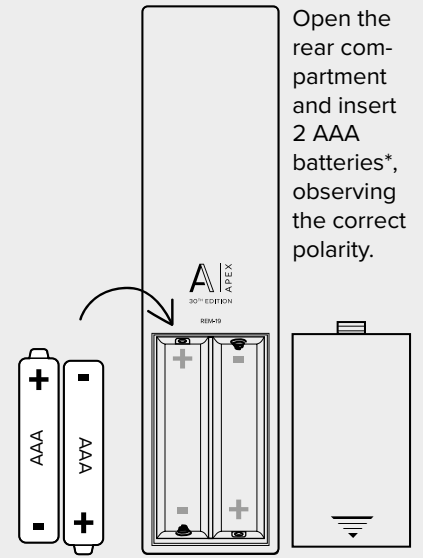

Open the rear compartment and insert 2 AAA batteries*, observing the correct polarity.

*batteries not included

Approximately 6m, angle of 30 degrees on each side, the IR receiver is located halfway between the volume button and the display.

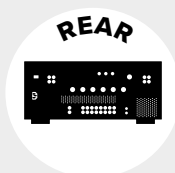
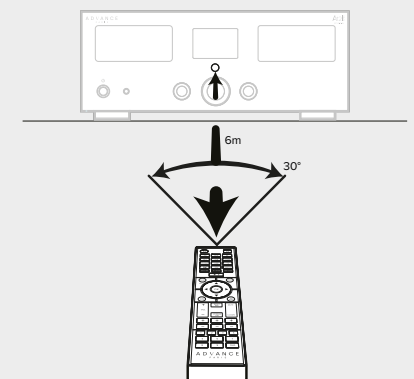



EN

CONTENTS

DESCRIPTION

CONNECTIONS

USE

SETTINGS

FAQ

APPENDICES

Check that the operating voltage is correctly set on the rear panel of your amplifier and corresponds to the voltage in your country.

Please connect all your sources **BEFORE** connecting the amplifier to the mains.



Connecting sources while your amplifier is switched on may expose your speakers to loud noise and cause your speakers to fail.

Speakers	.11-13
Subwoofer	.14
Television	.15
Home cinema	.16-17
Turntable	.18
Sources	.19
Computer	.20
Bluetooth	.21
Recording device	.22
Wired headset	.23
External amplifier	.24
Simultaneous Switch On	.25
Power cord	.26

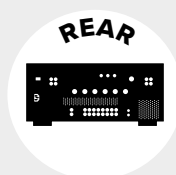



CONTENTS

DESCRIPTION

CONNECTIONS

USE

SETTINGS

FAQ

APPENDICES

Speakers

Cable preparation

The terminals on your APEX amplifier are compatible with bare cables, spades and banana plugs.

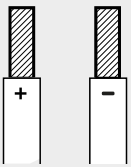

To connect your **bare cables**, you must remove 1 cm of the cable sheath. Unscrew the terminal blocks until the holes in the terminal block axis appear. Insert the bare cable and check that the copper strands do not come into contact with the neighbouring terminal block.

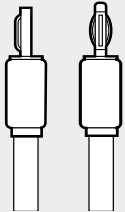

To connect your **cables with banana plugs**, you must remove the red and black blanking covers in the centre of the terminals. Then insert your various speaker cables, observing the polarity (red + and black -) and the sides (left and right).

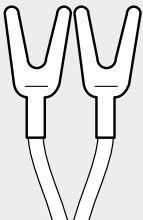

To connect your **cables with spade terminals**, unscrew each terminal block and insert the spade terminals. Then screw the terminal blocks back on, ensuring that the spade terminals do not touch each other.

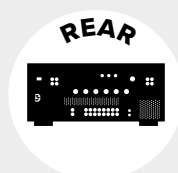

Speakers

Speaker connection Output A and Output B

Your amplifier can handle two different zones: Output A and Output B.

ZONES A

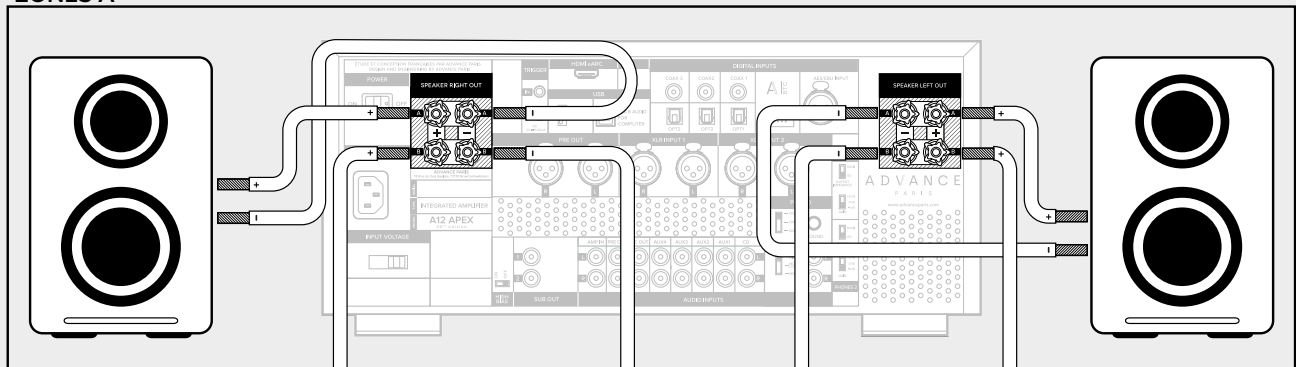

ZONE B



These outputs transmit the same signal. You can activate output A, output B, or both outputs simultaneously.

If you are using both outputs at the same time, you must ensure that you connect speakers with a **minimum** impedance of **8 ohms**.

See «Settings» for speaker output configuration.

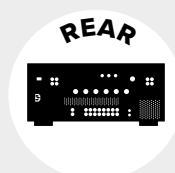



EN

CONTENTS

DESCRIPTION

CONNECTIONS

USE

SETTINGS

FAQ

APPENDICES

Speakers

Dual wiring connection

Some speakers have bi-wiring capability. You can bi-wire by doubling the cables between your APEX amplifier and your speakers.

To do this, you can double the connections on terminal block A (or terminal block B) or use outputs A and B. You must also remove the jumpers from your speaker terminals (see your speaker manual).

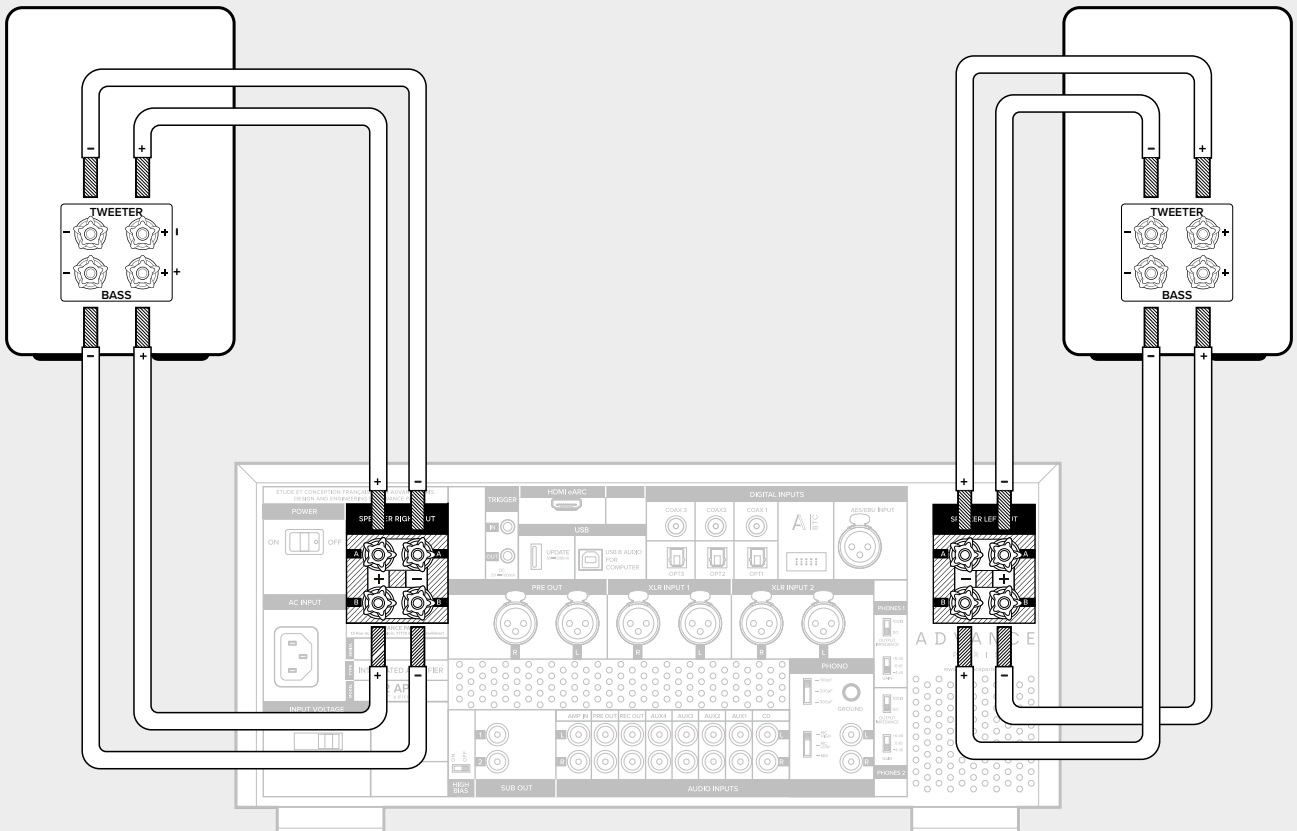

See «Settings» for speaker output configuration.

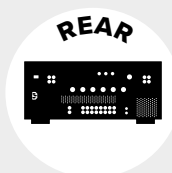



EN

CONTENTS

DESCRIPTION

CONNECTIONS

USE

SETTINGS

FAQ

APPENDICES

Subwoofer

Connecting subwoofers

Your APEX amplifier has a dual subwoofer output. You can connect a single subwoofer or two subwoofers.

If you connect a single subwoofer, you can use either output (1 or 2). Your amplifier must be set to MONO mode in the Subwoofer settings menu.

If you connect two subwoofers, you can use them in MONO or STEREO mode. Output 1 corresponds to the left side, and output 2 corresponds to the right side.

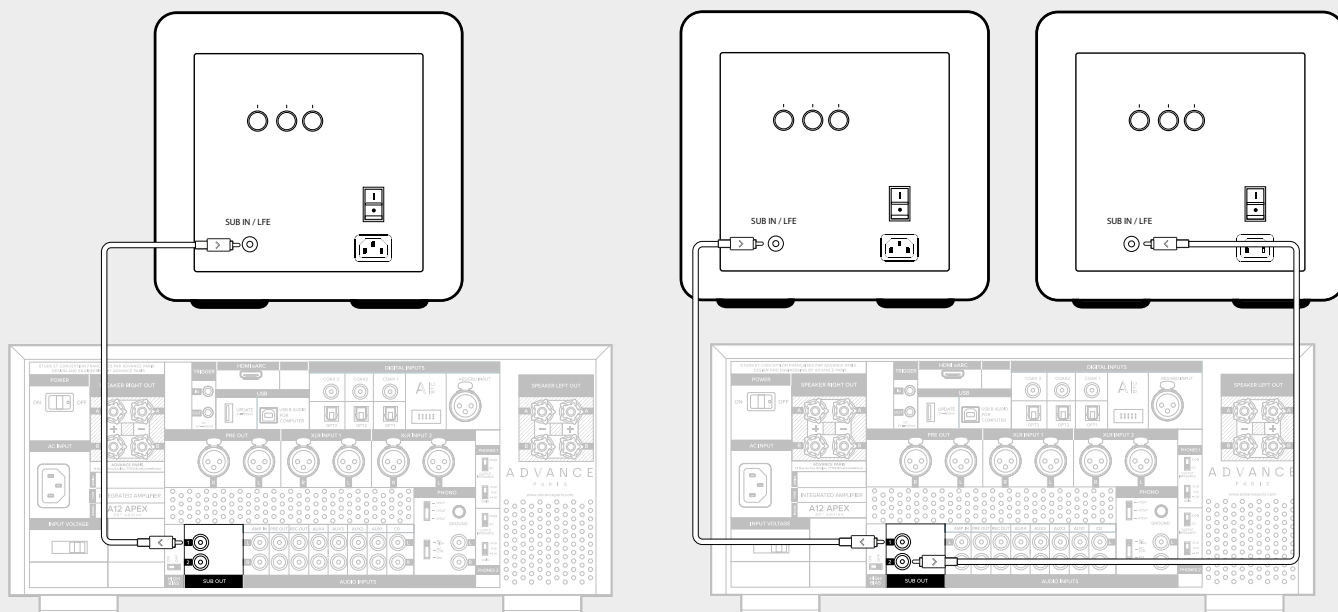

See «Settings» for configuring the subwoofer outputs.

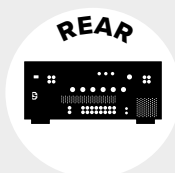

Television

HDMI eARC socket

Your APEX amplifier significantly enhances your TV sound experience by allowing you to use your speakers rather than your television's built-in speakers when watching television.

To enjoy this feature, simply connect an HDMI cable between your APEX amplifier and the HDMI ARC (or eARC) socket on your television.

You can also use your television remote only control to control the power, standby and volume of the APEX amplifier.

NOTE: your APEX amplifier is only compatible with stereo signals (not multichannel).

NOTE: If you change the input from HDMI on your APEX amplifier, it will no longer respond to commands sent by the television.

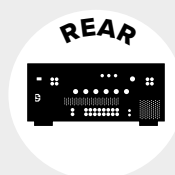
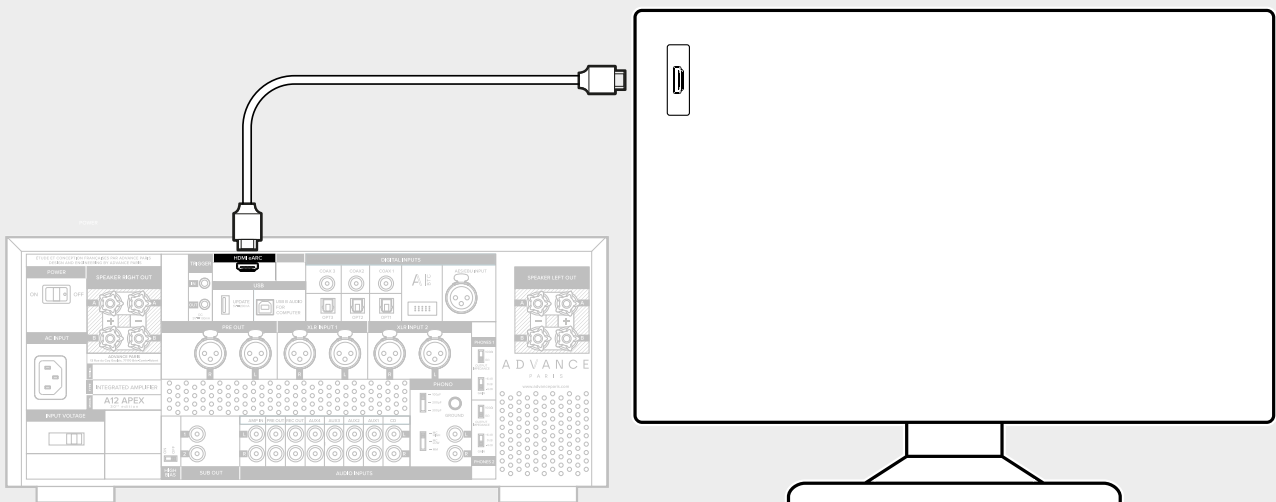



EN

CONTENTS

DESCRIPTION

CONNECTIONS

USE

SETTINGS

FAQ

APPENDICES

Home cinema

AMP-IN socket

To use your APEX amplifier as a power amplifier with your home cinema amplifier, connect them using the AMP-IN sockets on the rear panel. This connection allows the home cinema system to control the amplification of the front speakers, while benefiting from the audio quality of your APEX amplifier.

Connect the front PRE-OUT outputs (Front L/R) of your home cinema amplifier to the AMP-IN inputs of the APEX amplifier using an RCA cable.

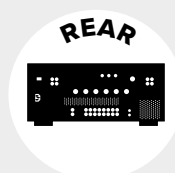
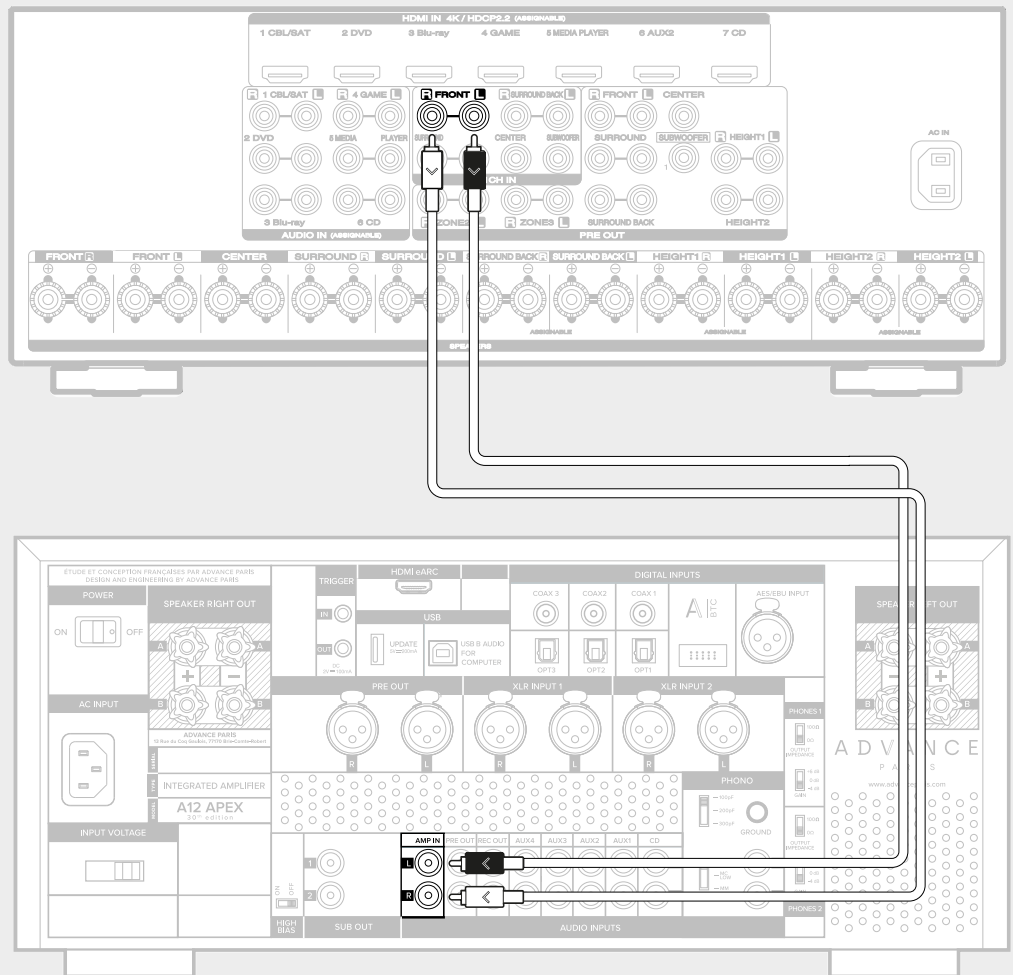



EN

CONTENTS

DESCRIPTION

CONNECTIONS

USE

SETTINGS

FAQ

APPENDICES

Home cinema

Trigger IN socket

When using your APEX amplifier as a power amp connected to your home cinema amplifier, you can automate the switching on and standby mode of the APEX amplifier using a 3.5mm mono cable (not supplied) between the trigger sockets of the two devices. You must check whether your home cinema amplifier has this jack (see its manual).

You must use the Trigger IN socket on the APEX amplifier. You must use the Trigger OUT socket on the home cinema amplifier.

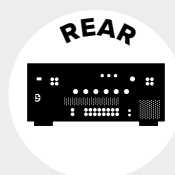
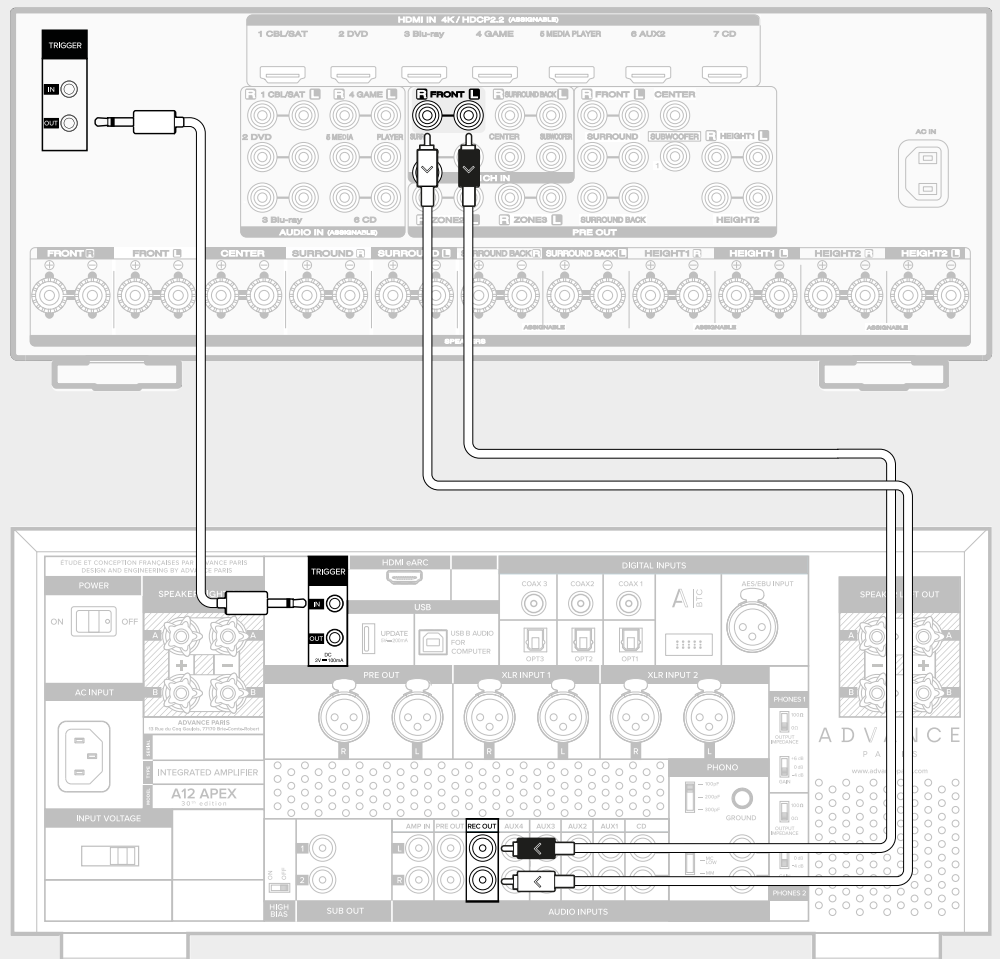



EN

CONTENTS

DESCRIPTION

CONNECTIONS

USE

SETTINGS

FAQ

APPENDICES

Vinyl turntable

Phono socket

To get the most out of your turntable, connect it directly to the Phono input of your APEX amplifier. This input is specially designed for **moving-magnet (MM) and moving-coil (MC) cartridges** it incorporates the RIAA preamplifier required for correct playback of vinyl records.

Also connect the ground cable from your turntable to eliminate any humming noises.

NOTE: it's important to make all connections with the APEX amplifier switched OFF. Connecting sources while your amplifier is switched on may expose your speakers to loud noise and cause your loudspeakers to fail.

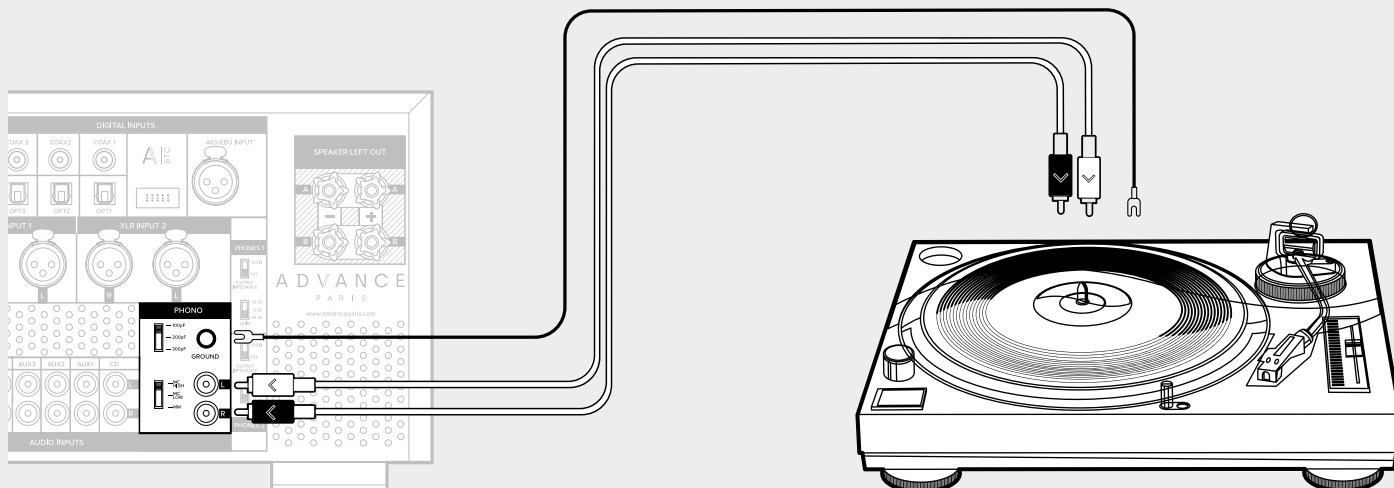

See «Settings» for Phono MM / MC input settings

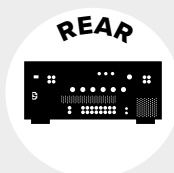



EN

CONTENTS	DESCRIPTION	CONNECTIONS	USE	SETTINGS	FAQ	APPENDICES
----------	-------------	-------------	-----	----------	-----	------------

Sources



CAUTION: Do not connect any source to the AMP-IN input. Doing so may result in high sound levels from your speakers and possible failure.

ANALOG INPUTS

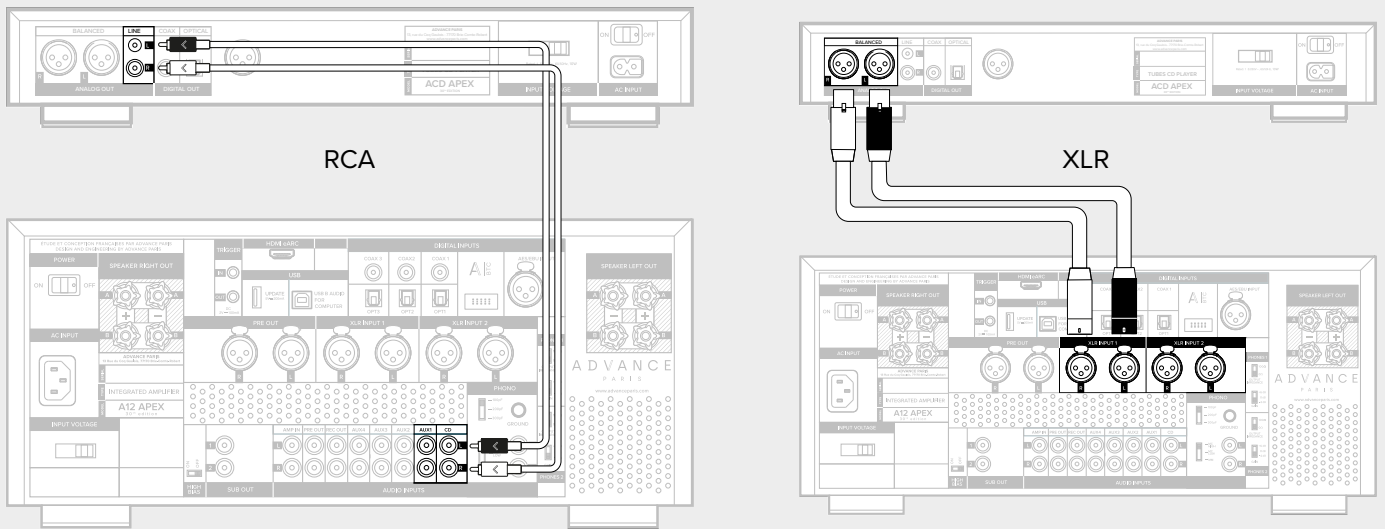

DIGITAL INPUTS

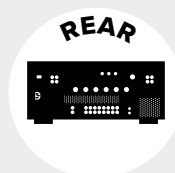
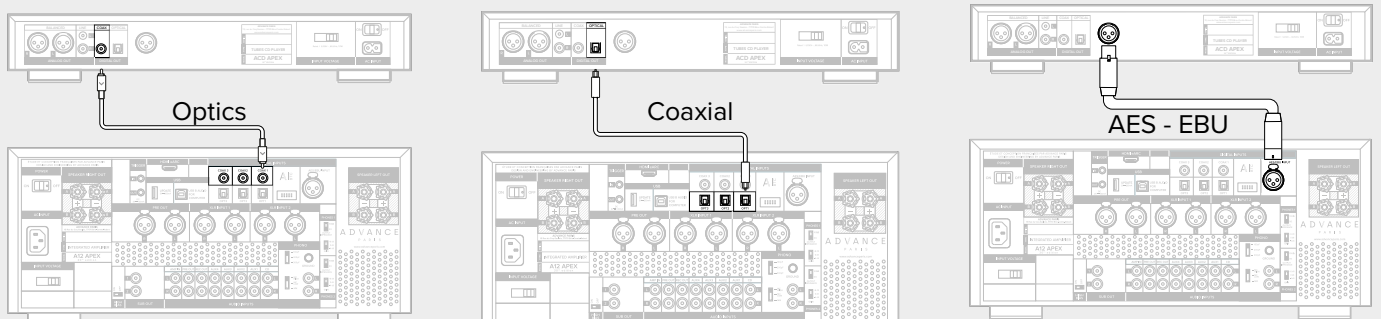



Computer

USB type B input

Compatible with APPLE OS and Windows 10-11 without drivers to be installed on your computer. USB 2.0 specification up to 24bit / 192kHz. DSD compatible 64 - 128 - 256

Select the Advance Paris audio output on your computer in the sound card settings.

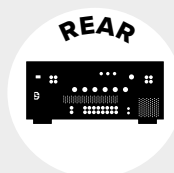
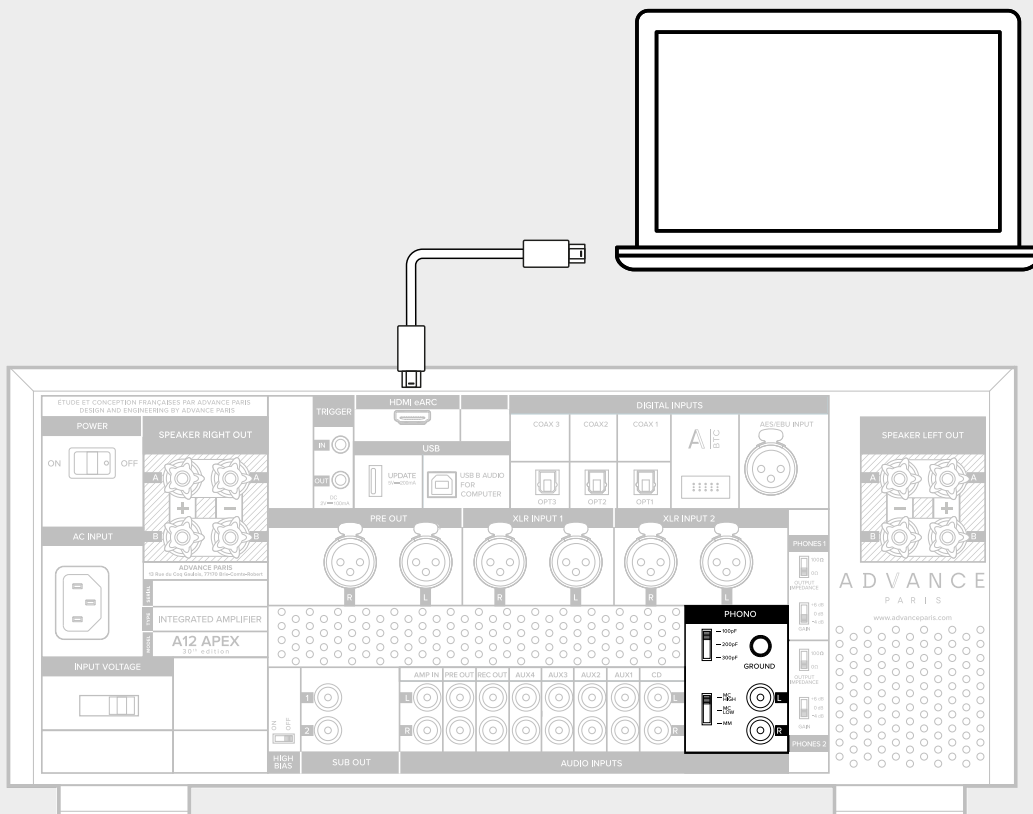



Bluetooth

A-BTC audio input

To connect a Bluetooth source to your APEX amplifier, you will need the Advance Paris A-BTC product (optional). The A-BTC must be inserted into the specific socket located on the rear panel of your APEX amplifier (the APEX amplifier must be switched OFF at its mains switch).

To connect Bluetooth headphones, you must also have an Advance Paris A-BTC product. The A-BTC must be inserted into the specific socket located on the rear panel of your APEX amplifier (the APEX amplifier must be switched OFF at its mains switch).

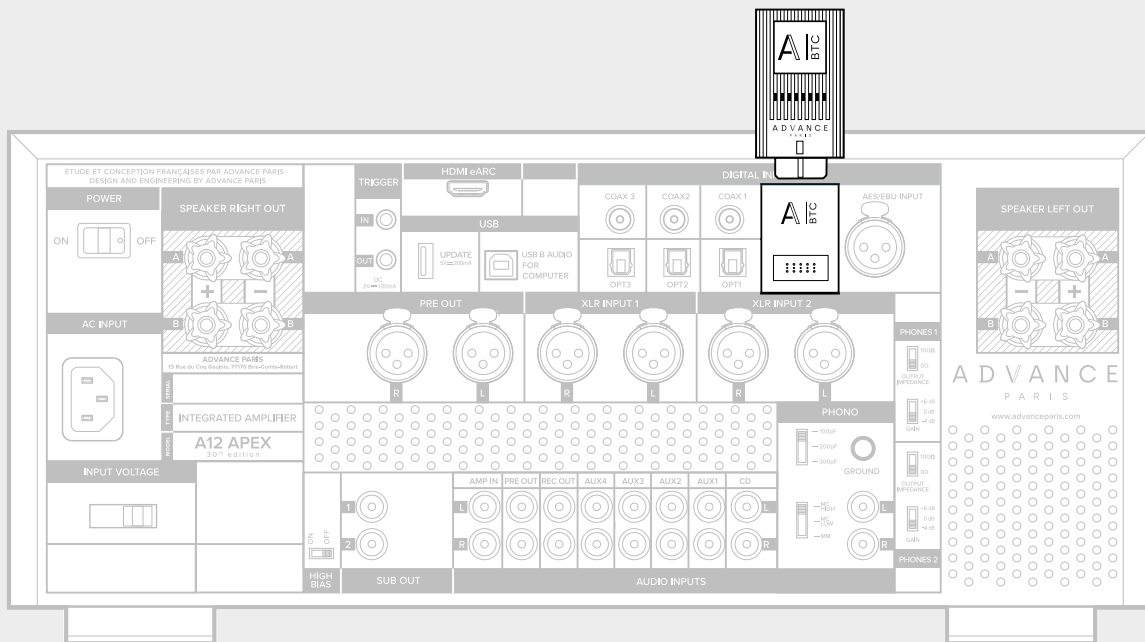

See «Operation» for details.

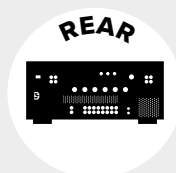



EN

CONTENTS	DESCRIPTION	CONNECTIONS	USE	SETTINGS	FAQ	APPENDICES
----------	-------------	-------------	-----	----------	-----	------------

Recording device

REC-OUT socket

You can connect a recorder to the REC-OUT socket

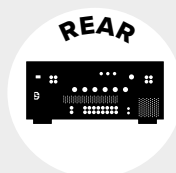
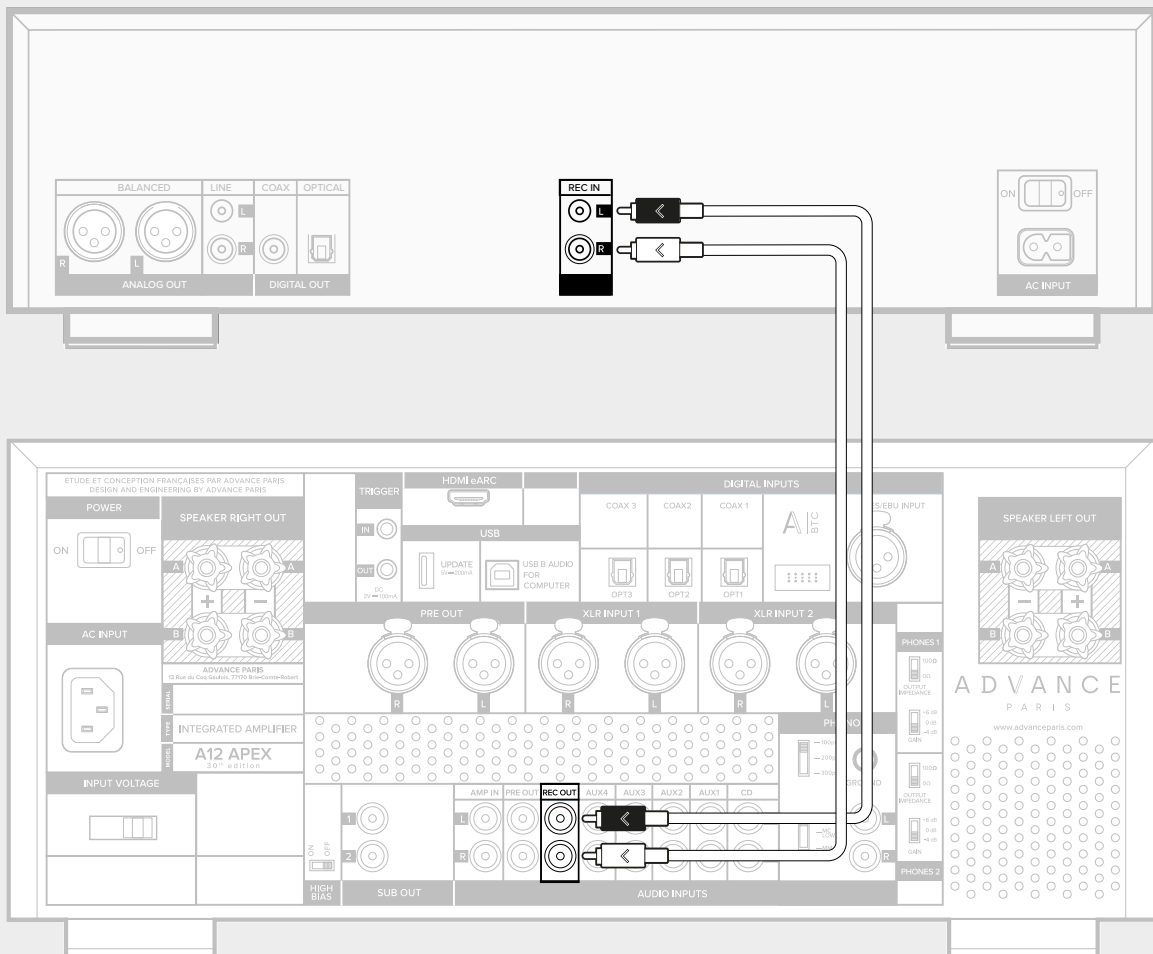



EN

CONTENTS

DESCRIPTION

CONNECTIONS

USE

SETTINGS

FAQ

APPENDICES

Wired headset

Connect your wired headphones to the 6.35mm or 3.5mm jacks on the front panel of the APEX amplifier.

The speaker outputs are muted when headphones are inserted on the front panel.

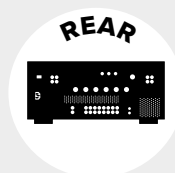
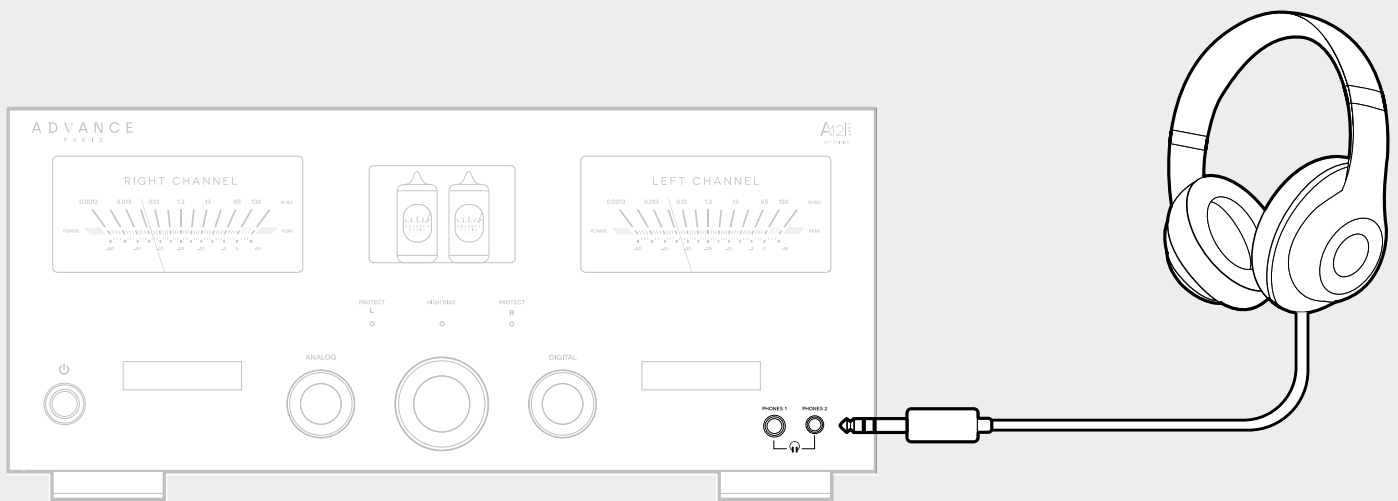



EN

CONTENTS

DESCRIPTION

CONNECTIONS

USE

SETTINGS

FAQ

APPENDICES

External amplifier

PRE-OUT socket

You can connect a mono or stereo power block to your APEX amplifier, giving you more power and audio quality, depending on your speakers.

Connect the PRE-OUT outputs of your APEX amplifier to the inputs of your power block with an RCA or XLR cable.

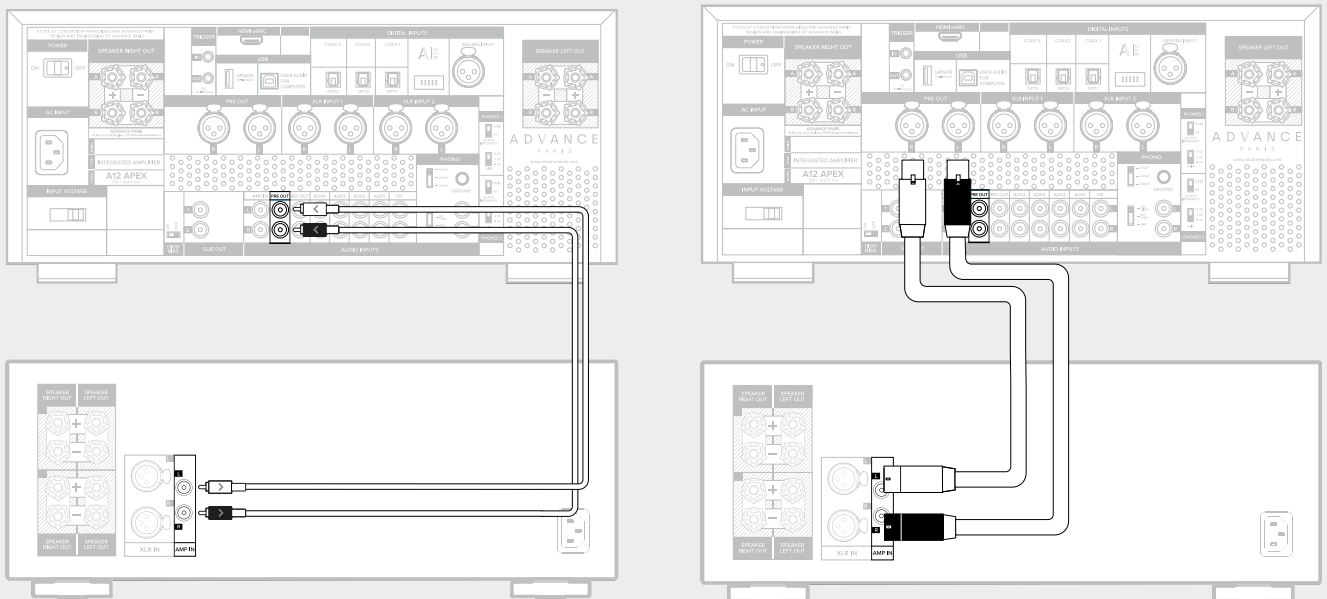

NOTE: your speakers will be connected to your external power supply (not to your APEX amplifier).

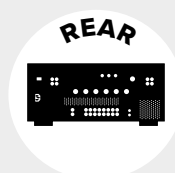



Simultaneous Switch On

Trigger OUT socket

You can activate a third-party product when you switch on your APEX amplifier. To do this, your third-party product must have a Trigger IN socket.

Connect a 3.5mm mono cable (not supplied) between the Trigger OUT socket on the APEX amplifier and the Trigger IN socket on your third-party product.

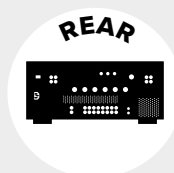
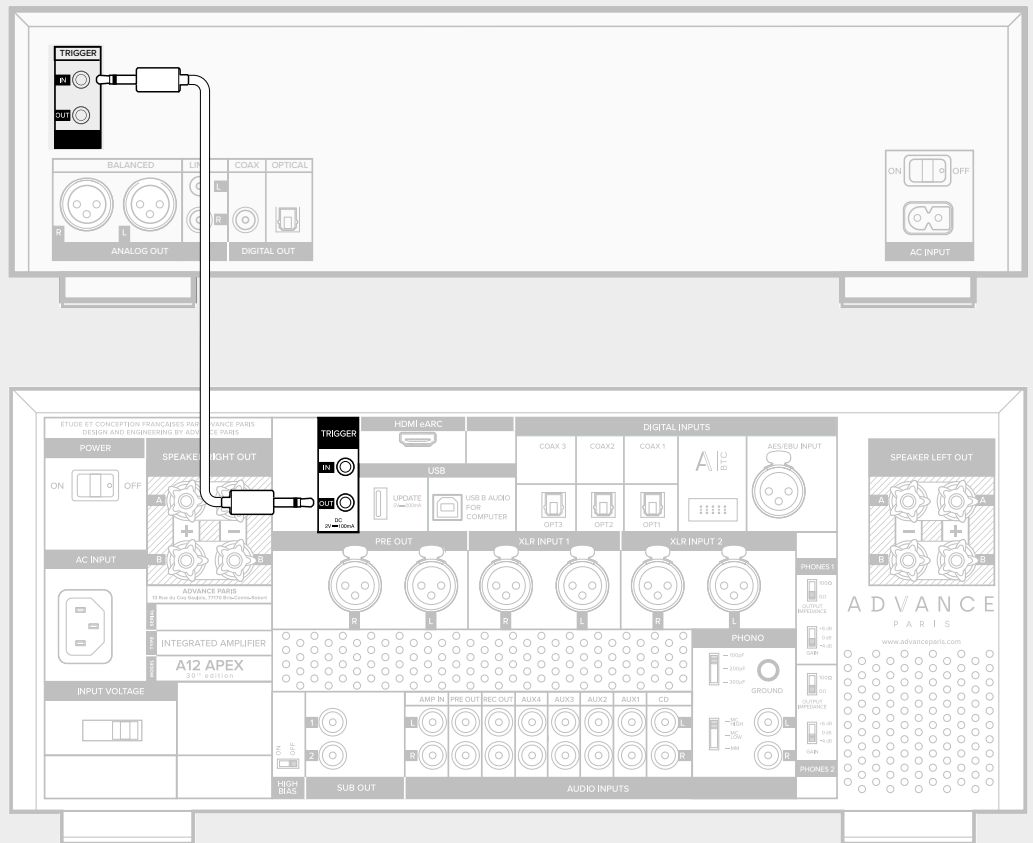



Power cord

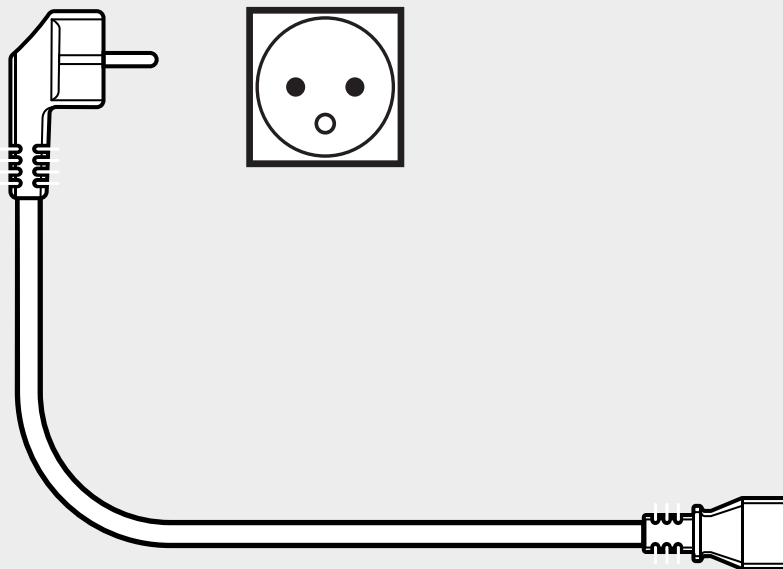

Cord connection

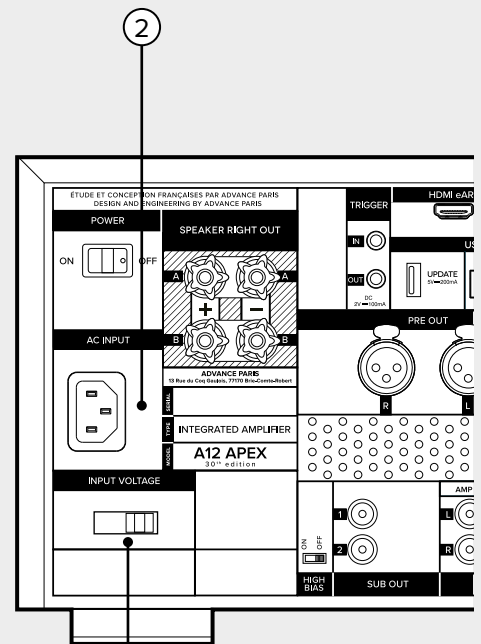

Voltage check

NOTE: It is important to check the voltage setting (1) before connecting the power cord (2). Failing to do so and sending the wrong voltage to the amplifier might destroy your APEX amplifier. BEWARE !

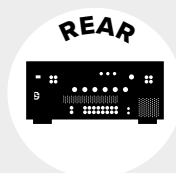



EN

CONTENTS	DESCRIPTION	CONNECTIONS	USE	SETTINGS	FAQ	APPENDICES
----------	-------------	-------------	------------	----------	-----	------------

Switch on	.28
Wake from Standby	.29
Selecting the input	.30
Volume adjustment	.31
Muting	.32
Connecting devices in	
Bluetooth with the A-BTC	.33
Bluetooth headset with A-BTC	.34
Television as an audio source	.35
APEX amplifier as power amplifier	.36
Using your turntable	.37

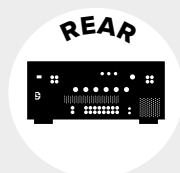



EN

CONTENTS

DESCRIPTION

CONNECTIONS

USE

SETTINGS

FAQ

APPENDICES

Switch on

Switch at the rear

- To use your APEX amplifier, you must set the mains switch on the rear panel to ON.

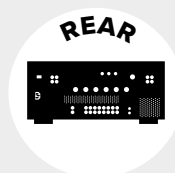
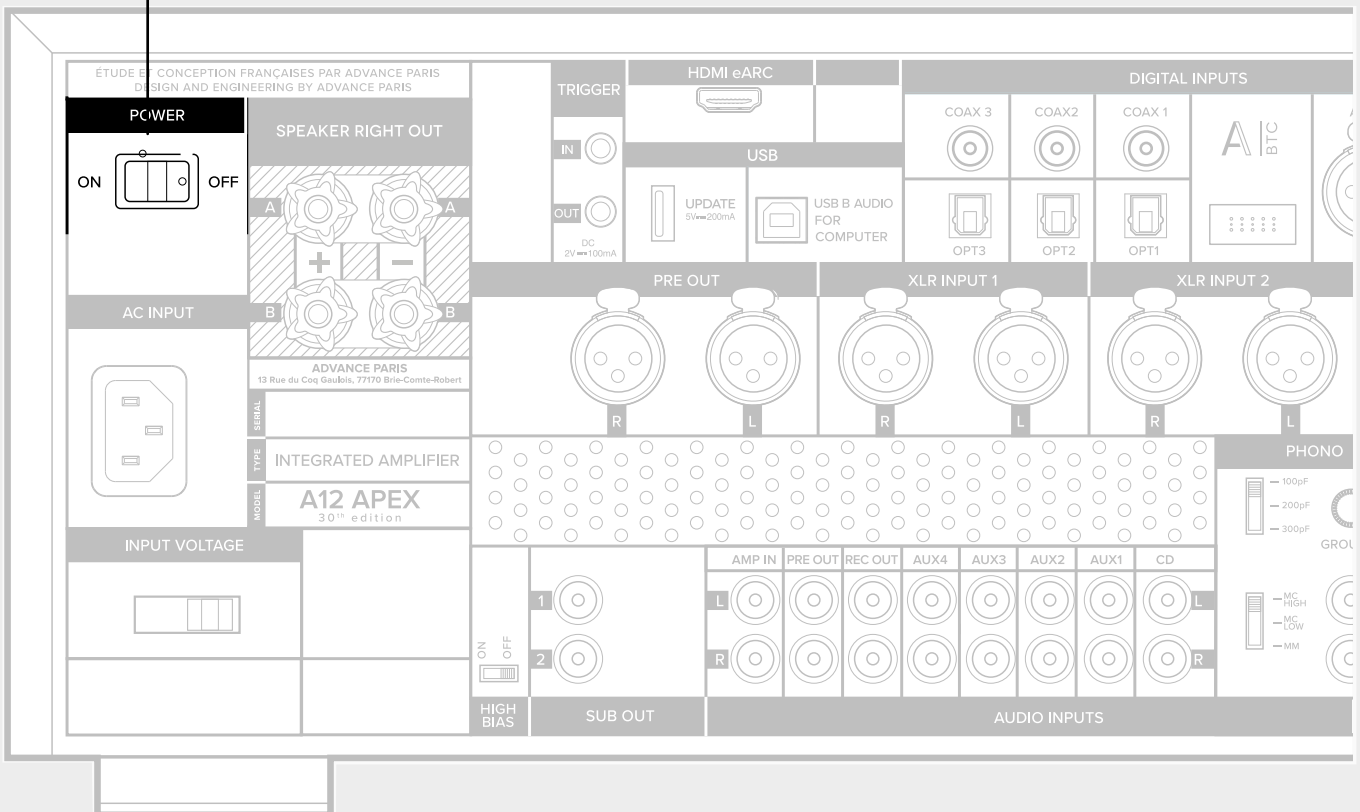



Wake from Standby

Front panel button - or - remote control

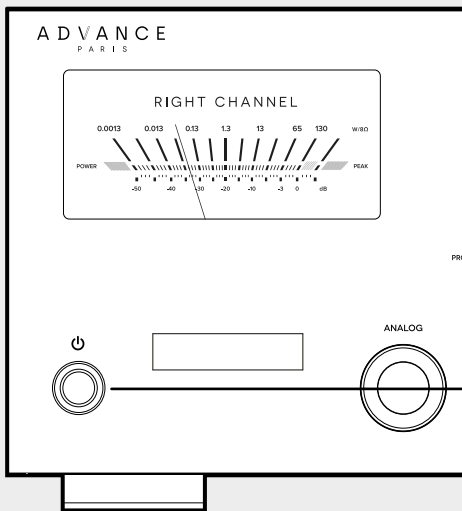

To switch on your APEX amplifier, use the remote control and its standby button or the standby button on the front panel of the APEX amplifier.



Your APEX amplifier has audio valves. A 30-second warm-up period is required. During this time, your amplifier will not emit any sound.

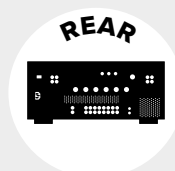



EN

CONTENTS

DESCRIPTION

CONNECTIONS

USE

SETTINGS

FAQ

APPENDICES

Selecting the input

Use your Remote control handset or multifunction button on the front panel

Your APEX amplifier has numerous inputs on its rear panel.



Once your sources are connected, you can select them using the remote control.

You can also use the ANALOG or DIGITAL buttons.

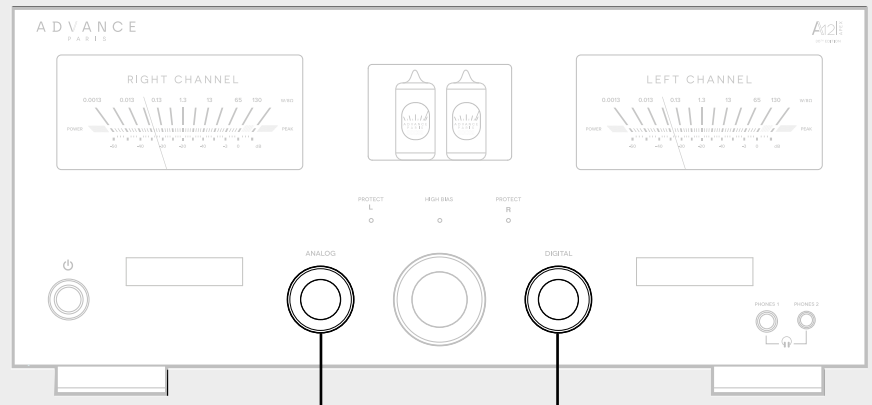

The ANALOG button is used to select analog inputs:
CD,
AUX (1-4),
XLR (1-2)
and Phono.

the DIGITAL button is for selecting digital inputs:
OPT (1-3),
Coax (1-3),
AES-EBU,
HDMI eARC,
Bluetooth (A-BTC),
USB audio (computer).

Input selection is confirmed automatically after 3 seconds, or by pressing the ANALOG or DIGITAL button.

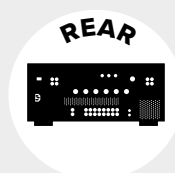



EN

CONTENTS

DESCRIPTION

CONNECTIONS

USE

SETTINGS

FAQ

APPENDICES

Volume control

Front panel control or remote control handset

You can change the volume by turning the multifunction control on the front panel of your APEX amplifier. Turn clockwise to increase the volume. Turn anticlockwise to decrease the volume.

You can change the volume using the «Vol +» and «Vol -» buttons directly from the remote control. By holding down these buttons, you can quickly increase the volume.

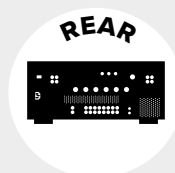
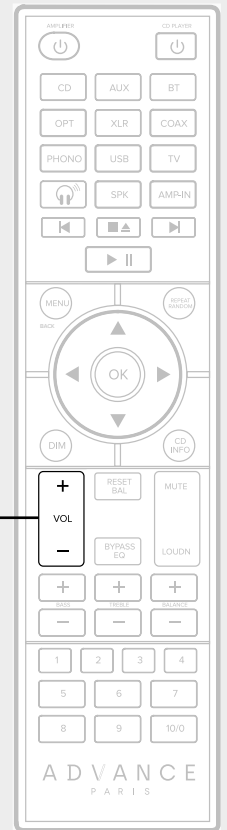
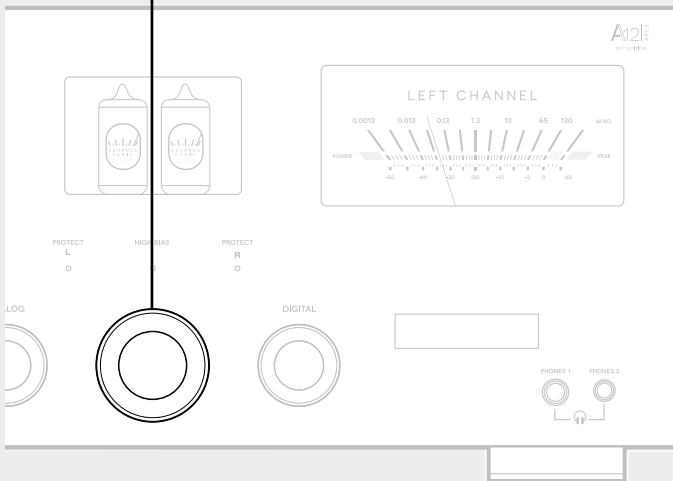



EN

CONTENTS

DESCRIPTION

CONNECTIONS

USE

SETTINGS

FAQ

APPENDICES

Muting

Remote control

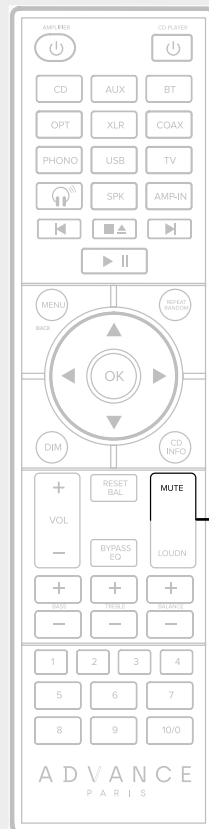

By pressing the «MUTE» button on the remote control, you can mute the sound completely.

Pressing the «MUTE» button again will return the sound to its original level. You can also press the «Vol +» or «Vol -» buttons to deactivate the «MUTE» function.

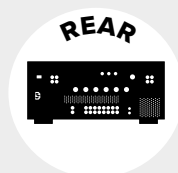



EN

CONTENTS

DESCRIPTION

CONNECTIONS

USE

SETTINGS

FAQ

APPENDICES

Devices connected via Bluetooth to the A-BTC

Switch ON your APEX amplifier and select the Bluetooth input. You must go to the Bluetooth settings on your Bluetooth source (phone, tablet, computer) and select A-BTC.

You can now send music to your APEX amplifier. Check the volume on your Bluetooth source and on your amplifier.

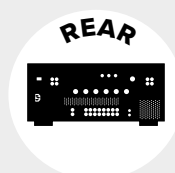
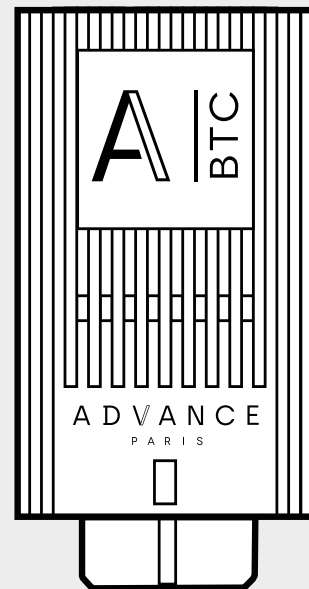

Bluetooth headset with A-BTC

Thanks to the Advance Paris A-BTC product (optional), your APEX amplifier can send sound to Bluetooth headphones (not included) so you can listen to music without disturbing your family members (or neighbours).

The analogue and digital inputs on your amplifier can be routed to Bluetooth headphones.

To activate this function, press the button with the headset icon on the remote control and start the pairing procedure from your headset (see the headset manufacturer's instructions). After 30 seconds, your Bluetooth headset and the A-BTC should connect to each other.

When using Bluetooth headphones, the volume must be adjusted directly on the headphones. Adjusting the volume on the remote control or using the multifunction button on the APEX amplifier will only change the volume of the speakers.

Please note: You cannot send the Bluetooth input back to a Bluetooth headset. In this case, a direct connection must be established between your Bluetooth source and your Bluetooth headset.

When using Bluetooth headphones, you can choose whether or not to mute the speakers. See «Settings» for more details.

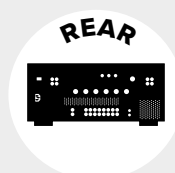
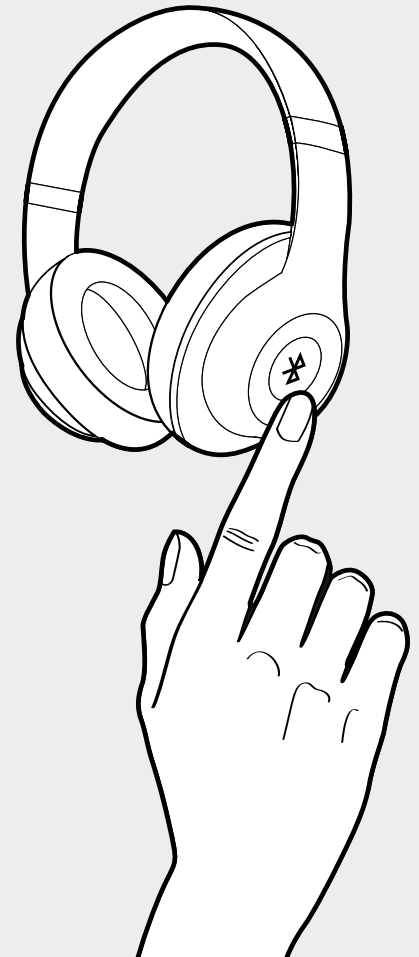
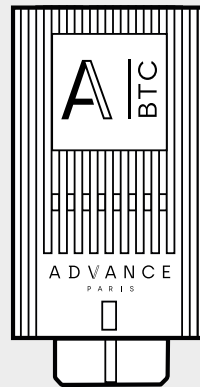



EN

CONTENTS

DESCRIPTION

CONNECTIONS

USE

SETTINGS

FAQ

APPENDICES

Television as an audio source

Front panel control or remote control handset

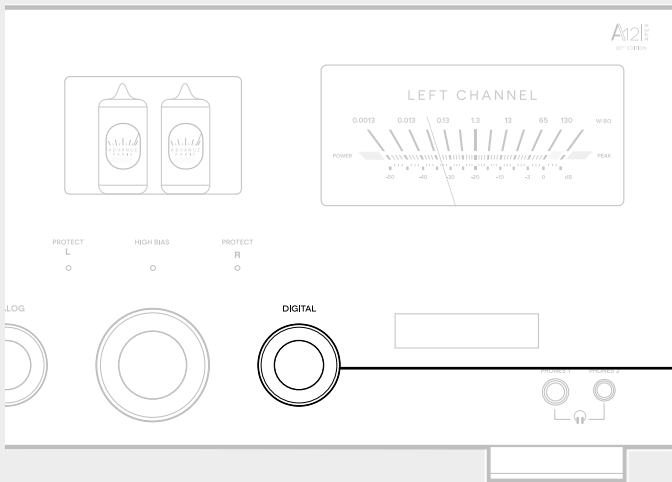

Once the HDMI cable has been connected between your APEX amplifier and TV set, you can select the TV input using the remote control or the DIGITAL button on the APEX amplifier (HDMI ARC input).

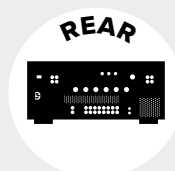
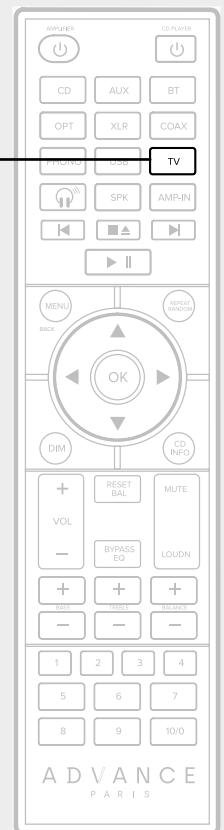



EN

CONTENTS

DESCRIPTION

CONNECTIONS

USE

SETTINGS

FAQ

APPENDICES

APEX as a power amplifier

Select the AMP-IN input on your stereo amplifier using the remote control.

Your home cinema amplifier will now manage the volume and sound balance of the front speakers during home cinema sessions.

Your installation is now complete. You can now enjoy the power and musical quality of your APEX amplifier while retaining the multi-channel functionality of your home cinema amplifier.

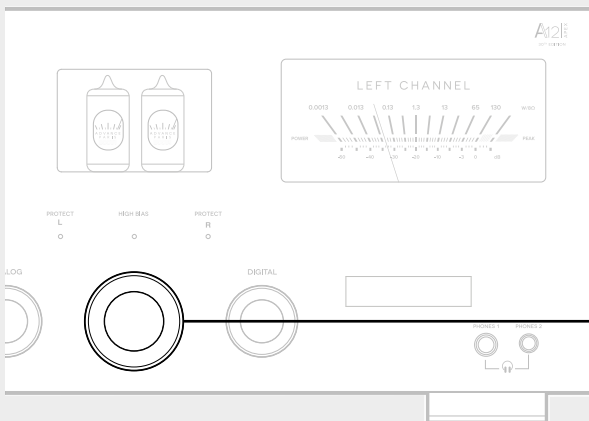

AMP-IN mode can also be activated via the settings menu on your APEX amplifier. To do so, navigate to the following menu:

MENU / AMP IN / ON.

It is advisable to perform an acoustic calibration of the entire system using your home cinema amplifier's calibration process to balance the level of all speakers. Refer to your home cinema amplifier's manual.

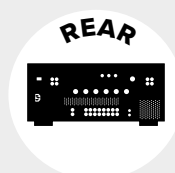



EN

CONTENTS

DESCRIPTION

CONNECTIONS

USE

SETTINGS

FAQ

APPENDICES

Using your turntable

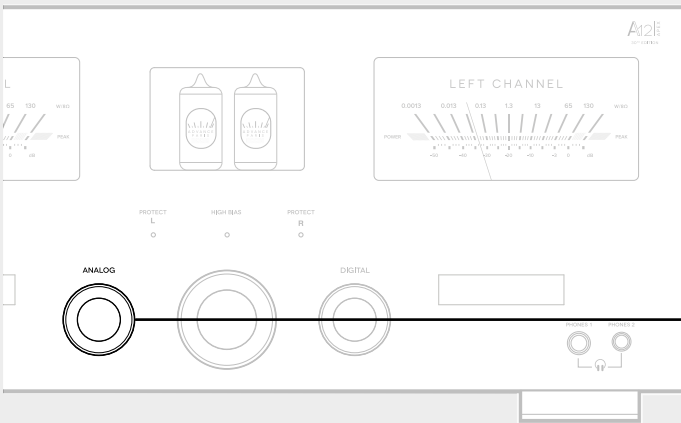

Select the Phono source on your APEX amplifier using the ANALOG button or the remote control (PHONO input).

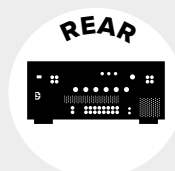



CONTENTS	DESCRIPTION	CONNECTIONS	USE	SETTINGS	FAQ	APPENDICES
----------	-------------	-------------	-----	-----------------	-----	------------

Setup menu (remote control)39
Setup menu (multifunction)40
Speaker (A/B) output configuration41
Subwoofer Output configuration42
Speaker adjustment while using a Bluetooth headset43
Display brightness44
Automatic standby mode45
Tone and balance46
Loudness47
Volume when switched ON48
Standby button49
Capacitance (PHONO input)50
Cell type setting51
Disable HDMI CEC control52
Reset53

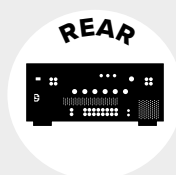



EN

CONTENTS

DESCRIPTION

CONNECTIONS

USE

SETTINGS

FAQ

APPENDICES

Settings menu (remote control)

By pressing the «MENU» button on the remote control, you can access the various settings menus for your APEX amplifier.

To return to the previous level, briefly press the 'MENU' button.



By pressing the directional buttons on the remote control, you can access the various settings menus for your APEX amplifier.

To enter a specific setting, you must briefly press the central «OK» button.

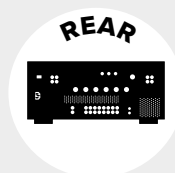
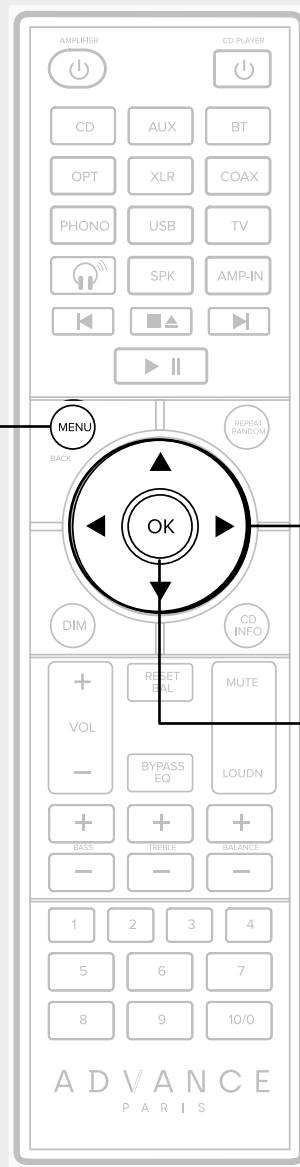



EN

CONTENTS

DESCRIPTION

CONNECTIONS

USE

SETTINGS

FAQ

APPENDICES

Setup menu (multifunction control)

How do I access the settings menu using the multifunction control?

By pressing and holding the multifunction control for more than one second, you can access the various settings menus on your APEX amplifier.

By turning the multifunction control, you can scroll through the various entries in the settings menu.

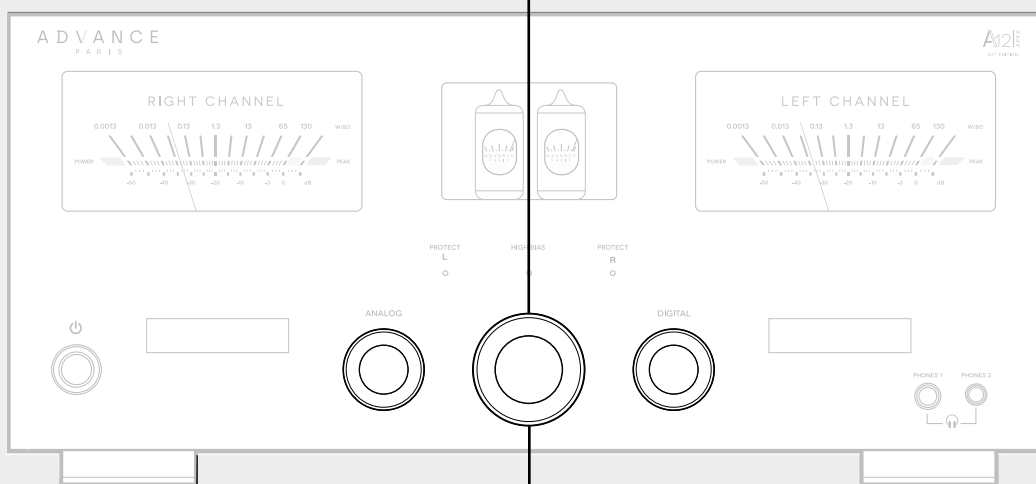

To access a specific setting, you must briefly press the multifunction control.

To return to the previous level, you must press and hold the multifunction control.

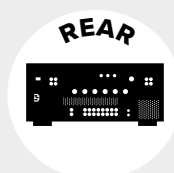



CONTENTS

DESCRIPTION

CONNECTIONS

USE

SETTINGS

FAQ

APPENDICES

Configuration of speaker output (A / B)

To adjust the speaker output you want to use, go to the following menu:

**MENU / SPEAKER / SPEAKER A or SPEAKER B
or SPEAKER A+B or SPEAKER OFF**

This setting is stored in memory and does not need to be made each time the system is switched on.

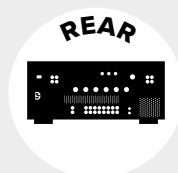



CONTENTS

DESCRIPTION

CONNECTIONS

USE

SETTINGS

FAQ

APPENDICES

Configuration of the subwoofer output

To configure the output mode for the subwoofers, you must go to the following menu:

MENU / SUB MODE / MONO or STEREO

The two subwoofer outputs are cut at 200 Hz with a slope of 12 dB per octave, $Q = 0.7$.

You need to configure volume and cut-OFF frequency on the subwoofer back panel.

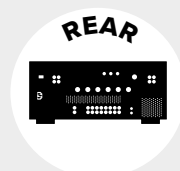



Adjusting the speakers when using Bluetooth headphones

When using Bluetooth headphones, you can choose whether or not to mute the speakers. By leaving the speakers on, you can have different volume levels between the headphones and the speakers. This can be helpful for someone who needs a high volume on their Bluetooth headphones compared with others listening on speakers.

To configure the speaker mute function when using Bluetooth headphones, you must go to the APEX amplifier settings menu:

MENU / BLUETOOTH OUT / SPK MUTE ON OR SPK MUTE OFF.

SPK MUTE ON: When using Bluetooth headphones, the speakers are inactive.

SPK MUTE OFF: when using Bluetooth headphones, the speakers are active.

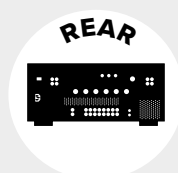



Brightness

DIM on the remote control

You can adjust the brightness of the VU meters and the display by repeatedly pressing the DIM button.

The brightness of the front panel buttons is not adjustable.

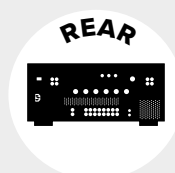
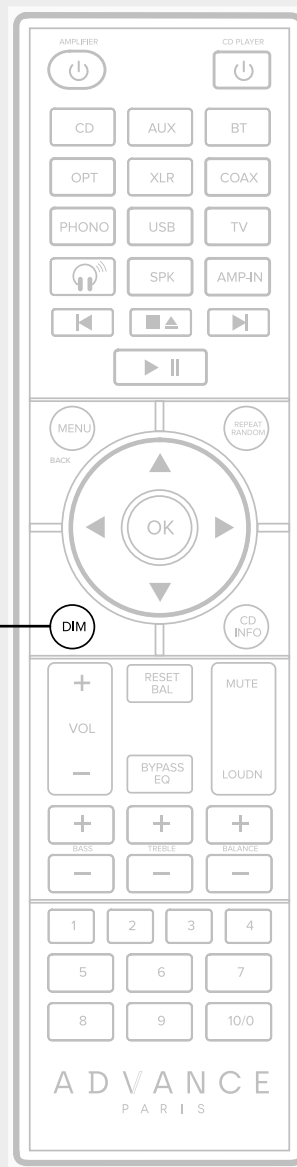



CONTENTS

DESCRIPTION

CONNECTIONS

USE

SETTINGS

FAQ

APPENDICES

Auto standby mode

Product display

MENU / APD SETTING

You can configure your amplifier to switch off automatically after a certain period of time without a signal.

OFF / 5 minutes / 10 / 20 / 30 / 60

When set to OFF, your amplifier will never switch off by itself.

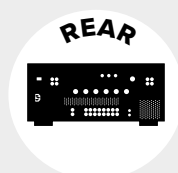



EN

CONTENTS

DESCRIPTION

CONNECTIONS

USE

SETTINGS

FAQ

APPENDICES

Tone and Balance

Remote control / product display

MENU / TONE

Bass, treble and balance settings are available on the remote control.

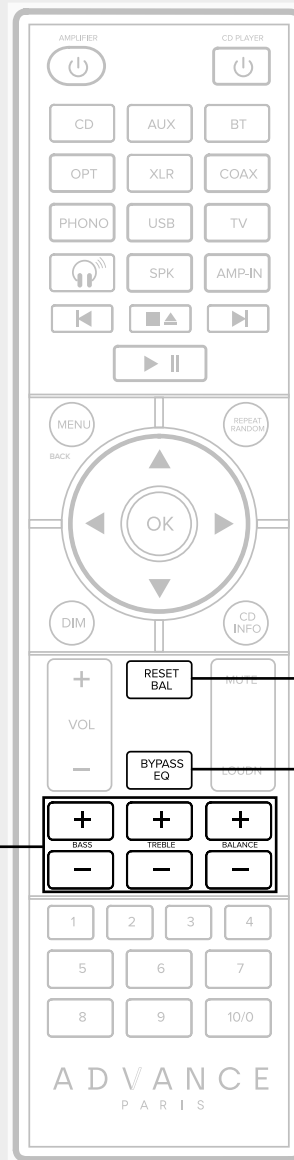

The Reset Bal button returns the scale to center.

The Bypass EQ button activates or deactivates your bass and treble settings.

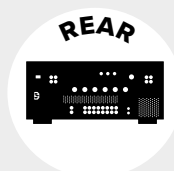



Loudness

Remote control / product display

MENU / TONE

On the remote control, the Loudness button allows you to enable or disable the Loudness feature.

Loudness compensates for the loss of sensitivity in the ears at low and high frequencies when listening at low volume.

Your amplifier will dynamically correct bass and treble frequencies based on your listening volume to achieve the most natural sound balance possible: at low volume, the correction is significant; at medium volume, the correction is moderate; at high volume, the correction is zero.

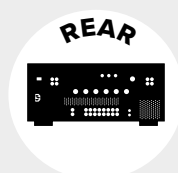



CONTENTS

DESCRIPTION

CONNECTIONS

USE

SETTINGS

FAQ

APPENDICES

Volume level when switched ON

Product display

MENU / VOL SET / ON / OFF

When set to ON, you can activate a specific volume each time you start up your APEX amplifier. When set to OFF, your APEX amplifier will start up with the same volume as when it was put into standby mode.

MENU / VOL SET / VOL DEF

You can set the start-up volume level here once you have set the previous step to ON.

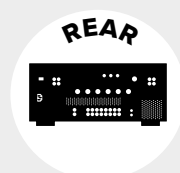



Standby button

Product display

MENU / STB LED MODE

You can deactivate the red light on the Standby button on the front of your amplifier. When in standby mode, the Standby button will no longer light up red.

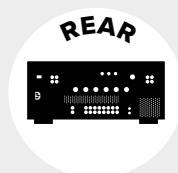



CONTENTS

DESCRIPTION

CONNECTIONS

USE

SETTINGS

FAQ

APPENDICES

Capacitance (PHONO input)

Your APEX amplifier has a capacitance setting on the Phono MM input, allowing you to adapt the electrical load to your turntable's cartridge.

This setting optimizes frequency response and guarantees a sound reproduction faithful to the recording.

Consult the specifications of your MM cartridge: most cartridges recommend a total capacitance of between 100 pF and 200 pF, including the turntable cable. Adjust the capacitance value of the APEX amplifier according to this recommendation.

A capacitance that is too low can give a clearer sound, but sometimes too sharp.

A capacitance that is too high can make the sound softer, but can also cause a loss of precision in the treble.

Carry out some comparative listening to validate the setting that offers the most natural tonal balance.

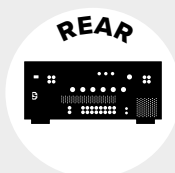

Setting Cell type

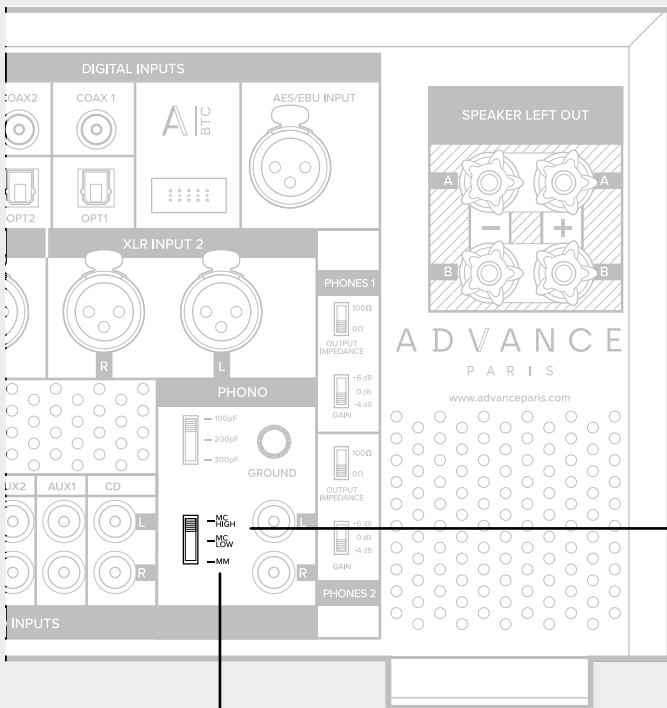

For MM or MC cartridge

Your APEX amplifier has a 3-position setting (MM, MC High, MC Low) to suit your turntable cell type.

For an MC cell, you must select MC High or MC Low. This will depend on the output voltage of your cell:

- For an MC cell with an output voltage below 0.6mV, you can use MC Low.

- For an MC cell with an output voltage above 0.6mV, you can use MC High.

For an MM cell, select MM.

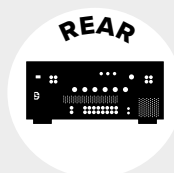



CONTENTS

DESCRIPTION

CONNECTIONS

USE

SETTINGS

FAQ

APPENDICES

Disable HDMI CEC control

Product display

MENU / CEC CONTROL

When set to ON, your amplifier will respond to commands sent by your television to coordinate the switching on or standby mode of the APEX amplifier and television.

When set to OFF, your APEX amplifier will not respond. Volume controls, on the other hand, are permanently activated regardless of the CEC CONTROL setting

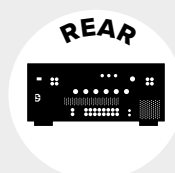



High-Bias Setting

Your APEX amplifier uses class AB amplification. The APEX amplifier therefore operates in class A at low power levels (below 5W) and in class B at higher power levels. It has a bias setting that can be configured to two positions: OFF and ON.

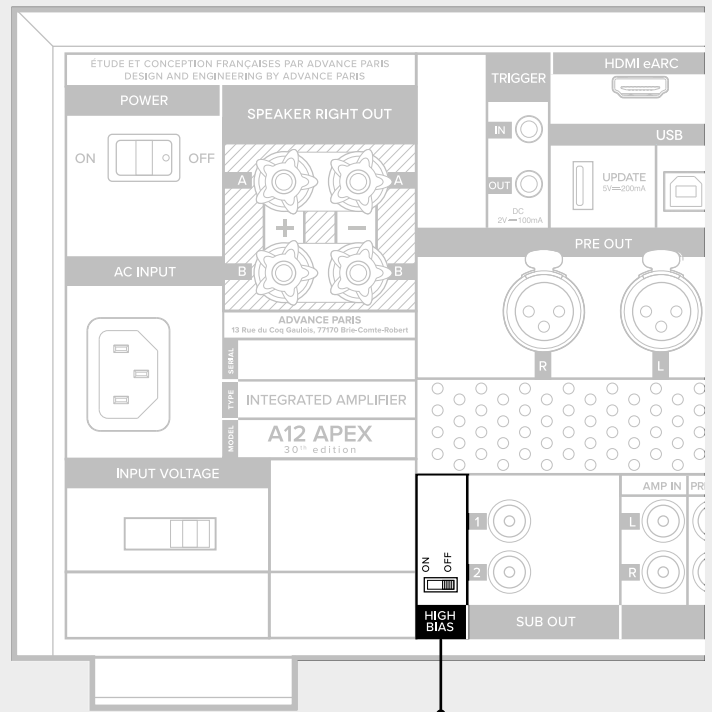

> OFF is the “normal” setting.

> ON is the “High-Bias” setting with higher Class A power (approximately 8-10 W).

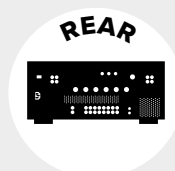



CONTENTS

DESCRIPTION

CONNECTIONS

USE

SETTINGS

FAQ

APPENDICES

Reset

Product display

MENU / RESET

If necessary, you can reset all settings on the APEX amplifier to their factory defaults.

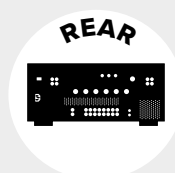



CONTENTS	DESCRIPTION	CONNECTIONS	USE	SETTINGS	FAQ	APPENDICES
----------	-------------	-------------	-----	----------	------------	------------

Internal software information56
Update57
Frequently asked questions58

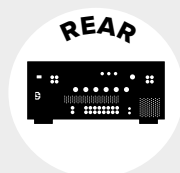



CONTENTS

DESCRIPTION

CONNECTIONS

USE

SETTINGS

FAQ

APPENDICES

Internal software information

To find out which version of internal software your APEX amplifier is running, you need to go to the following menu:

MENU / SYS INFO

By turning the multifunction control, you can scroll through the information. The internal software corresponds to the «MCU VERSION».

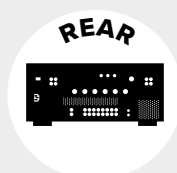



CONTENTS

DESCRIPTION

CONNECTIONS

USE

SETTINGS

FAQ

APPENDICES

Software update

If an update is required, after installing the update file on a USB key, you must plug this key into the UPDATE port on the back of the APEX amplifier.

Start the update by going to the menu on the APEX amplifier:

MENU / MCU UPD / YES .

The amplifier launches the update and goes into standby mode when the update process is complete. The USB key must be formatted in FAT (possible from Apple OS and Windows)

NOTE: updates are available on the Advance Paris website
See the product page: www.advanceparis.com



FACE



REAR



REMOTE CONTROL





Frequently asked questions

- **The power supply does not switch on/off**
 - > Check that the mains cable is properly connected.
 - > Check that the mains switch on the rear of the APEX amplifier is in the ON position.
- **Operations cannot be performed via the remote control.**
 - > Check/replace the batteries in the remote control.
- **No sound is emitted**
 - > Check that you have selected the input you want to listen to
 - > Check that the «MUTE» function is not activated
 - > Check that the speaker output (A or B) is enabled in the settings menu.
- **The desired audio is not being played**
 - > Check that you have selected the correct input.
- **The sound is distorted or there is unwanted noise**
 - > Contact your after-sales service
 - > Possible need to change the preamplifier tubes
- **The sound from my record player is not good.**
 - > Ensure that your turntable is correctly connected to the PHONO input on the APEX amplifier.
 - > Check the adjustable settings on the turntable.
- **No sound from a USB stick plugged into the rear port**
 - > The USB A «UPDATE» port is not compatible with audio files; it is only intended for updates when necessary.
- **I do not have sound from my television on my speakers.**
 - > If you have used an HDMI cable between the APEX amplifier and your television, check that the CEC/HDMI ARC (or e-ARC) feature is enabled on your television. Set the television's audio output to stereo (or PCM). Refer to the television's manual.

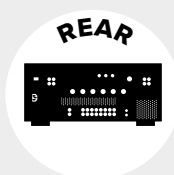



- CONTENTS
- DESCRIPTION
- CONNECTIONS
- USE
- SETTINGS
- FAQ
- APPENDICES**

Glossary60-62
Dimensions/weight63
Specifications64

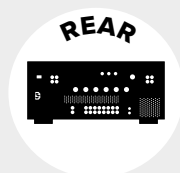



Glossary

A-BTC	Optional Bluetooth module from Advance Paris to be inserted into the dedicated socket on the rear of Advance Paris amplifiers to enable connection of Bluetooth sources or headphones.
Display	Screen located on the front of the amplifier for displaying information (source, volume, settings, etc.).
AMP-IN	Input allowing the APEX amplifier to be used as a power unit, for example in a home cinema system.
Amplifier (amp)	A device that amplifies audio signals from various sources in order to power loudspeakers.
Terminal block A / Terminal block B	Connectors located at the rear of the amplifier for connecting one or two pairs of speakers.
Bluetooth	Wireless transmission technology enabling connection of a compatible device via the A-BTC module.
Standby button	Button for switching the amplifier on or putting it into standby mode.
Speaker cables	Cables used to connect the speakers to the amplifier terminals.
Capacitance	Specific setting for the MM phono input to optimise the reproduction of a vinyl cartridge.
Coaxial (digital input)	Digital input using a coaxial cable to transmit sound.
Power cord	Power cable for connecting the amplifier to an electrical socket.

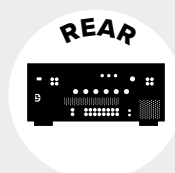



CONTENTS

DESCRIPTION

CONNECTIONS

USE

SETTINGS

FAQ

APPENDICES

AUX input	Stereo analogue inputs for connecting various sources.
MM phono input	Input specially designed for turntables equipped with moving magnet (MM) cartridges.
Optical Input	Digital inputs using an optical cable (Toslink).
Spades	Type of connector for speaker cables that attaches around the terminal block.
GROUND	Ground terminal to reduce interference noise when connecting a turntable.
HDMI ARC eARC	HDMI connection for transmitting sound between the television and the amplifier, with volume control and standby function.
High-Bias	Amplifier operating mode allowing Class A listening on the first few watts.
Infrared (IR)	Infrared transmission system enabling the remote control to communicate with the amplifier.
Mains switch	Main switch to turn the device on or off completely.
PRE-OUT	Output enabling the audio signal to be sent to an external power amplifier.
RCA	Red and white analogue connectors used for audio connections.
REC-OUT	Output for connecting a recording device.
Subwoofer	Speaker designed to reproduce very low frequencies (bass). It complements the main speakers to provide greater depth and impact in the bass range. Can be connected in single (mono) or dual (stereo) configuration depending on the amplifier settings.

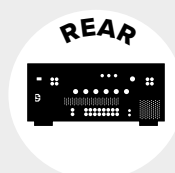



CONTENTS

DESCRIPTION

CONNECTIONS

USE

SETTINGS

FAQ

APPENDICES

Trigger IN / Trigger OUT

Connectors for synchronising the switching on or off of the amplifier with other devices.

USB type B

Input allowing you to connect a computer to use the amplifier as a USB sound card.

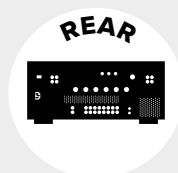



CONTENTS

DESCRIPTION

CONNECTIONS

USE

SETTINGS

FAQ

APPENDICES

Dimensions / Weight

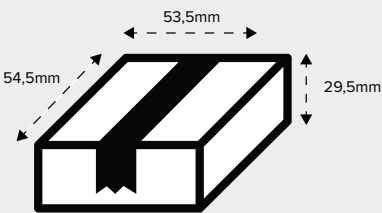
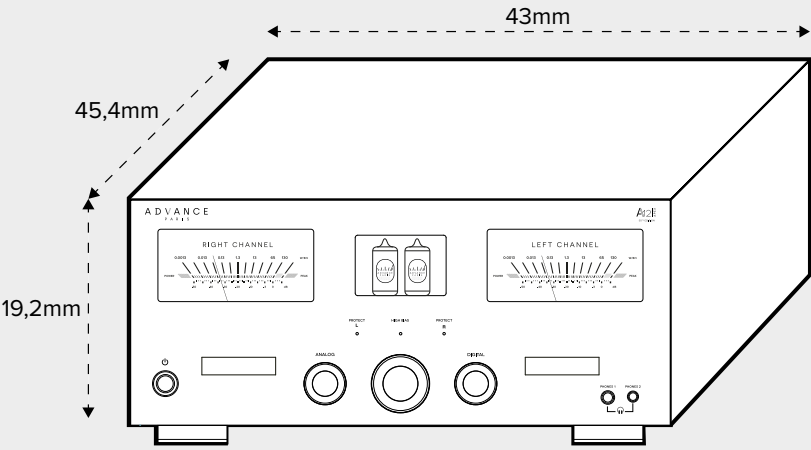
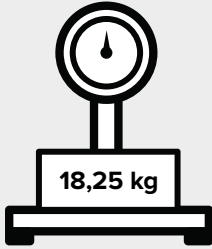
<p>PACKAGING DIMENSIONS</p> 	<p>PRODUCT DIMENSIONS</p> 
<p>PRODUCT WEIGHT</p> 	

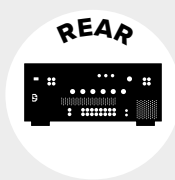

Specifications

Output power 8Ω	190W (THD+N 1%, 1kHz, 2 active channels)
Output power 4 Ω	292W (THD+N 1%, 1kHz, 2 active channels)
Frequency response (+/-1dB)	20Hz &gt; 80 kHz (43W, 8 Ω)
THD+N distortion	0.047% (1 kHz, 135W, 8 Ω)
Signal-to-noise ratio	104.8 dB (1 kHz, 135W, 8 Ω)
AC input compatibility	115/230V 50/60Hz with switch
Transformer type / power	(2x) Toroidal / (2x) 280 VA
DAC	ESS9039
Digital inputs	(3x) Optical: 24bit - 192kHz PCM (3x) Coaxial: 24bit - 192kHz PCM (1x) USB audio 24bit/192 kHz PCM - DSD64 - DSD128 HDMI eARC: PCM Stereo AES-EBU: 24bit - 192kHz PCM
A-BTC input	For Bluetooth A-BTC receiver (optional)
Analog inputs	LINE level RCA (5x) - PHONO level MM/MC (1x) + GROUND Line level XLR (2x)
Analog outputs	REC-OUT (x1), PRE-OUT (x1) RCA - (1x) XLR, SUB-OUT (x2)
Headphone jack	6.35mm jack, 3.5mm mini-jack
High-Bias	Yes, ON/OFF switch
Update	Via USB key on «UPDATE» port
Speaker terminals	(2x) Screw terminals compatible with bare cable, fork and banana plugs
Remote control	Infrared, REM-19, compatible with A12 APEX and ACD
Trigger socket	(2x) Input and output, 12V
Product dimensions (WxHxD in cm)	43x19,2x45,4
Packaging dimensions (WxHxD in cm)	54,5x29,5x53,5
Gross weight (kg) / Net weight (kg)	21,9 / 18,25
Model n°	A12 APEX 30TH EDITION
EAN Code	3 760 179 292 770

